

Osäfe

MCB

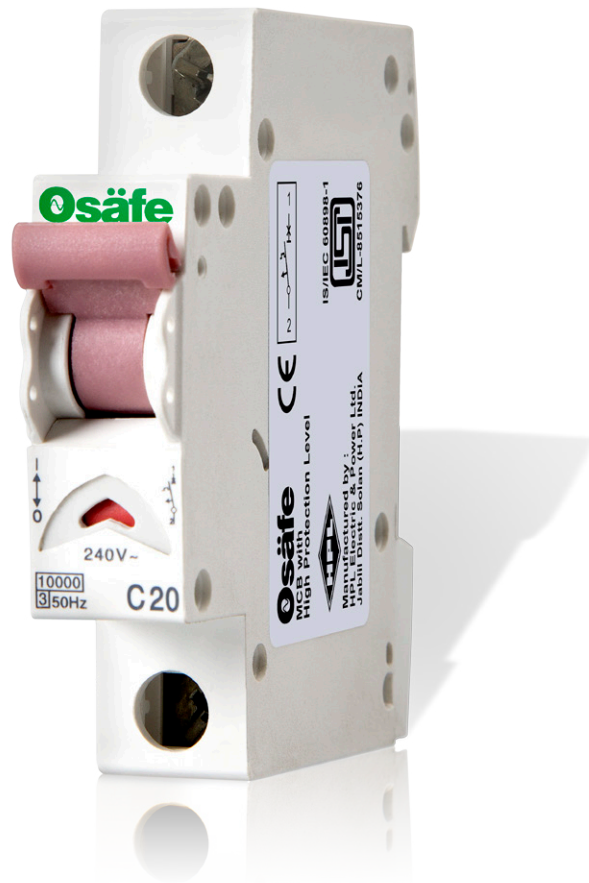

Elegance and
precision engineering
in the same breath.

Range : upto 63Amps.
Available in SP, SPN, DP, TP, TPN & FP version also

Designed by **HPL**



HPL Established in 1956, is among the leading players in the electrical industry today. HPL is a company with a strong innovative tradition, constantly striving for new levels of excellence, developing innovative products and solutions. HPL product range features high quality electronic energy meters, switchgears, Lighting, wires & cables, as well as modular switches and accessories. With its strong R&D, HPL introduces one more innovative product with our latest technology.. Osafe MCB.

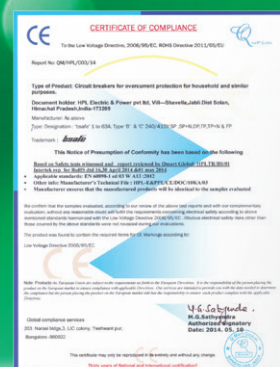

"If he can make a beautiful MCB like Osafe, he can surely make my 1987 wintage bottle."



"If he can make a beautiful MCB like Osafe, he can surely make my red carpet dress."



"If he can make a beautiful MCB like Osafe, he can surely make a pin-up sports car."

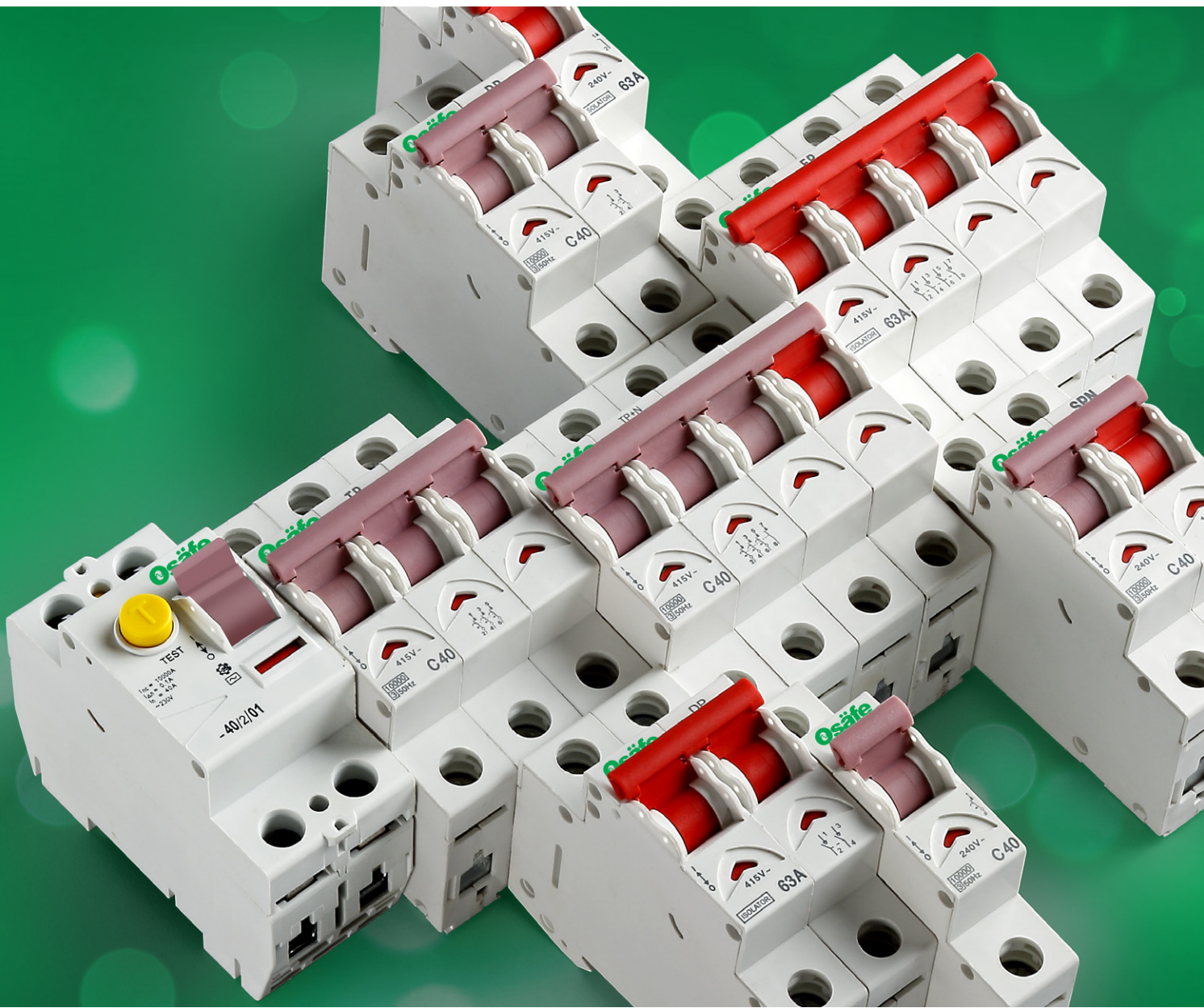

- Protection against overload & Short Circuit.
- Widest Range 0.5A to 63 A.
- High Breaking Capacity – 10KA
- With IP 20 Protection on Live Parts.
- With contact Position indicator
- Tested as Per IS/IEC 60898-1 : 2002 & 2003
- RCCB available 25A, 40A, 63 Amp, 80Amp in 30mA, 100mA, 300mA leakage tripping current.
- Tested as per IEC 610008-1, IS 12640-1



ISO 9001-2015



IS/IEC 60898-1



CML-8515376





Miniature Circuit Breakers 10kA

- Contact position indicator red / green
- Secure terminal connection
- 3-position DIN rail clip, permits removal from existing busbar system
- Comprehensive range of accessories suitable for subsequent installation
- Rated currents up to 63 A
- Tripping characteristics B, C, D
- Rated breaking capacity 10 kA
- Tested as per IS/IEC 60898-1 : 2002 & 2003
- IP20 degree of protection



Connection Diagrams

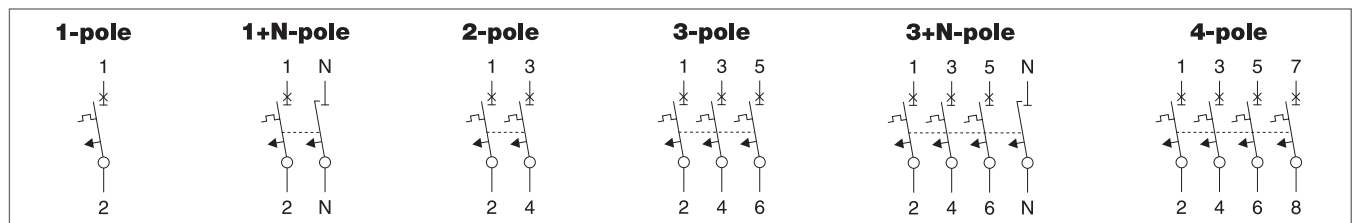

Range

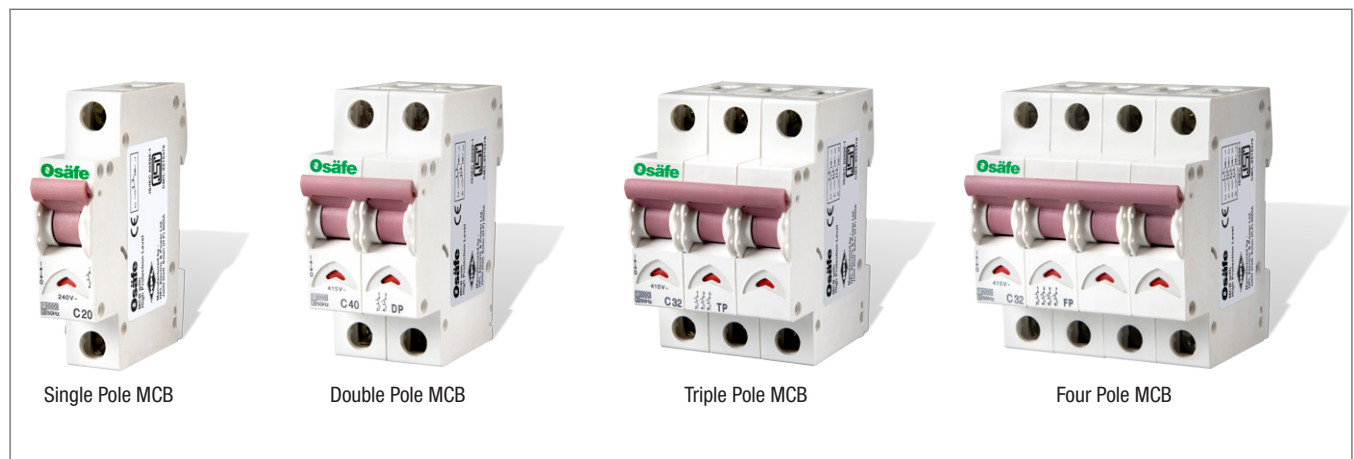



Pad Lock

MCB Dolly can be pad locked in both ON/OFF conditions for safety during maintenance and to limit the electricity consumption.

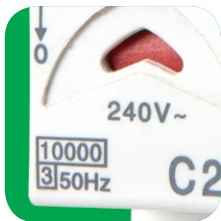

Contact Position Indicator

RED - ON

GREEN - OFF

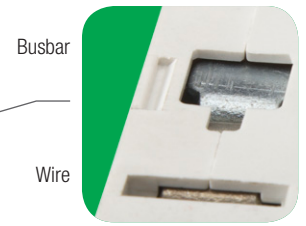

Busbar

Wire

Cable Termination upto 35mm² Cable



3 Position Mounting Clip

Permits installation and removal without removing busbar.

Design according to

Osäfe : AC IS/IEC 60898-1

Osäfe : DC IS/IEC 60898-2

Breaking capacity

Osäfe : AC 10kA (as per IS/IEC 60898-1)

Characteristics B, C, D

Rated Voltage V_{AC} 240/415V

V_{DC} 24V, 48V, 60V, 110V & 220V (Per pole)



Miniature Circuit Breakers 10kA

- High selectivity between MCB and back-up device due to low let-through energy
- Compatible with standard busbar
- Busbar positioning optionally above or below
- Meets the requirements of insulation co-ordination, distance between contacts > 4 mm, for secure isolation
- Rated breaking capacity 10 kA
Tested as per IS/IEC 60898-1: 2002.
- All range tested as per IEC 60898-1 : 2003.
- Tested at 16kA Icu as per IEC 60947-2, SPC 16A

	ACCESSORIES:	TECHNICAL SPECIFICATIONS	CODE
A	AUXILIARY SWITCH*	6A 1N0+1NC	bAUX61N0+1NC
B	SHUNT TRIP RELEASE*	OPERATIONAL VOLTAGE a) 12-110-AC/12-60 VDC b) 110-415V AC/110-220 VDC	bSTR24 bSTR240
C	UNDER VOLTAGE RELEASE*	a) 240 V/WITHOUT DELAY b) 415 V/WITHOUT DELAY	bUVR240 bUVR415

*Under Development

Technical Data Osäfe

Electrical

Design according to	IS/IEC 60898-1 IS/IEC 60898-2
Current test marks as	printed on the device
Rated voltage	AC: 240/415V DC: 24V, 48V, 60V, 110V & 220V (per pole)
Rated frequency	50 Hz
Rated breaking capacity according to IS/IEC 60898	10 kA
Characteristic	B, C, D
Back-up fuse	max. 125 A gG
Selectivity class	3
Endurance	4000 operating cycles On Load & Off Load
Terminal	Un marked (Line/Load) reversible

Mechanical

Frame size	45 mm
Device height	80 mm
Device width	17.5 mm per pole (1MU)
Mounting	quick fastening with 3 lock-in positions on DIN rail EN 50022
Degree of protection	IP20
Upper and lower terminals	open mouthed/lift terminals
Terminal protection	finger and hand touch safe,
Terminal capacity	1-35 mm ²
(1p+N, 1.5MU)	1-35 mm ² / 1-2x10 mm ² (N)
Terminal fastening torque	2-2.4 Nm
(1p+N, 1.5MU)	2-2.4 Nm / 1,2-1,5 Nm (N)
Busbar thickness	0.8 - 2 mm
Mounting	independent of position

Connection Diagrams

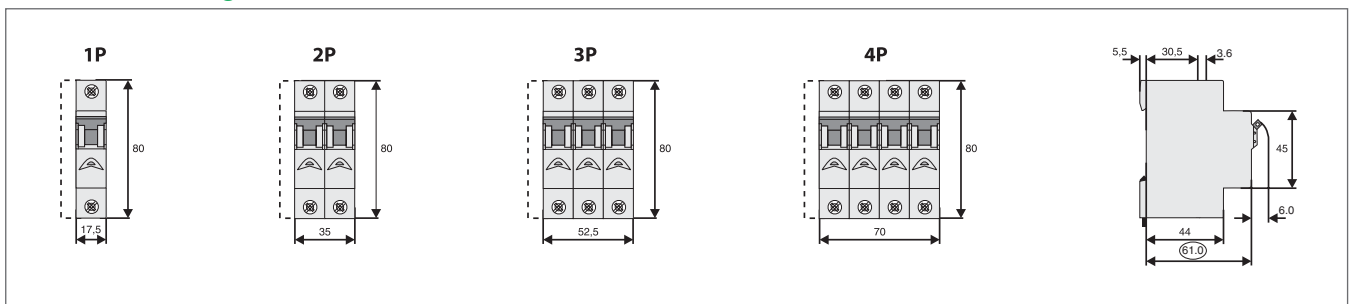

all dimension are in mm.

DC MCB UPTO 63 AMPS

TECHNO MCB specially designed for DC application has been developed by HPL's world class R&D to meet the market's stringent requirements for DC circuits.

AVAILABILITY

DC MCBs are available in SP & DP configuration from 0.5 Amp to 63 Amp in various voltages such as 12V, 24V, 48V, 60V, 110V, & 220V.

FEATURES

- Dual tripping system-overload through precisely calibrated bimetal and short circuit through electromagnetic coil.
- DC MCB incorporates a built in permanent magnet, which directs the arc into the arc quenching chamber.
- Free from nuisance tripping caused by vibrations.
- Time constant < 5ms
- DC MCB offers a unique feature of knob assuming mid trip position in the event of fault. This enables clear visual indication of the faulty circuit.
- Housing of DC MCB is made up of fire retardant, anti-cracking and non-hygroscopic PBT/Nylon.
- Contacts are made up of silver inlaid copper, which ensure low resistance and longer life of circuit breaker.

Tripping Characteristics (IS/IEC 60898)

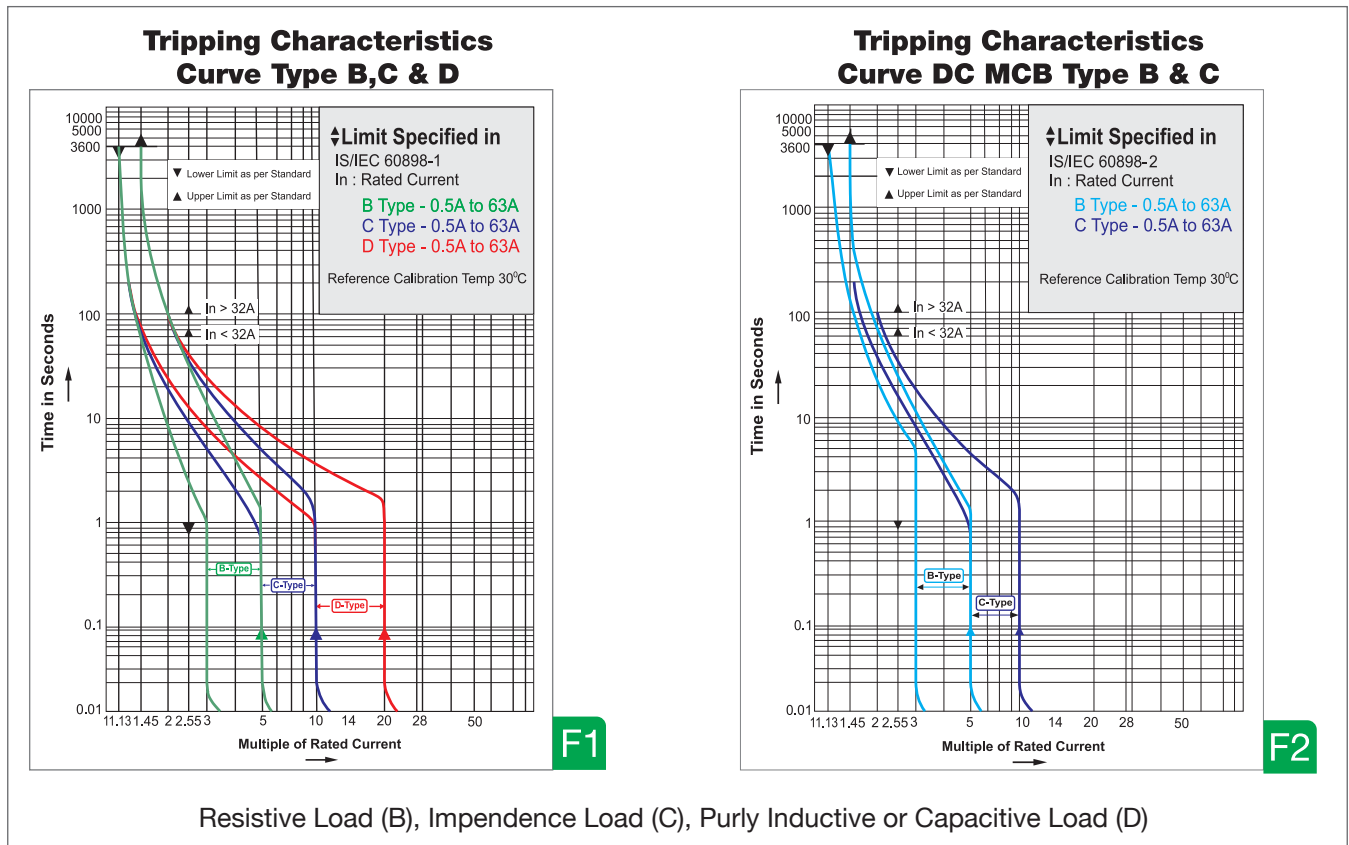



Effect of the Ambient Temperature on Thermal Tripping Behaviour

Adjusted rated current values according to the ambient temperature

I _n [A]	Ambient temperature T [°C]												
	-25	-20	-10	0	10	20	30	35	40	45	50	55	60
0.5	0.61	0.60	0.58	0.56	0.54	0.52	0.50	0.49	0.48	0.47	0.46	0.45	0.44
1	1.2	1.2	1.2	1.1	1.1	1.0	1.0	0.99	0.97	0.95	0.93	0.90	0.89
1.5	1.8	1.8	1.7	1.7	1.6	1.6	1.5	1.5	1.5	1.4	1.4	1.4	1.3
1.6	2.0	1.9	1.9	1.8	1.7	1.7	1.6	1.6	1.5	1.5	1.5	1.4	1.4
2	2.4	2.4	2.3	2.2	2.2	2.1	2.0	2.0	1.9	1.9	1.9	1.8	1.8
2.5	3.1	3.0	2.9	2.8	2.7	2.6	2.5	2.5	2.4	2.4	2.3	2.3	2.2
3	3.7	3.6	3.5	3.4	3.3	3.1	3.0	3.0	2.9	2.8	2.8	2.7	2.7
3.5	4.3	4.2	4.1	3.9	3.8	3.7	3.5	3.4	3.4	3.3	3.2	3.2	3.1
4	4.9	4.8	4.7	4.5	4.3	4.2	4.0	3.9	3.9	3.8	3.7	3.6	3.5
5	6.1	6.0	5.8	5.6	5.4	5.2	5.0	4.9	4.8	4.7	4.6	4.5	4.4
6	7.3	7.2	7.0	6.7	6.5	6.3	6.0	5.9	5.8	5.7	5.6	5.4	5.3
8	9.8	9.6	9.3	9.0	8.7	8.4	8.0	7.9	7.7	7.6	7.4	7.2	7.1
10	12	12	12	11	11	10	10	9.9	9.7	9.5	9.3	9.0	8.9
12	15	14	14	13	13	13	12	12	12	11	11	11	11
13	16	16	15	15	14	14	13	13	13	12	12	12	12
15	18	18	17	17	16	16	15	15	15	14	14	14	13
16	20	19	19	18	17	17	16	16	15	15	15	14	14
20	24	24	23	22	22	21	20	20	19	19	19	18	18
25	31	30	29	28	27	26	25	25	24	24	23	23	22
32	39	38	37	36	35	33	32	32	31	30	30	29	28
40	49	48	47	45	43	42	40	39	39	38	37	36	35
50	61	60	58	56	54	52	50	49	48	47	46	45	44
63	77	76	73	71	68	66	63	62	61	60	58	57	56

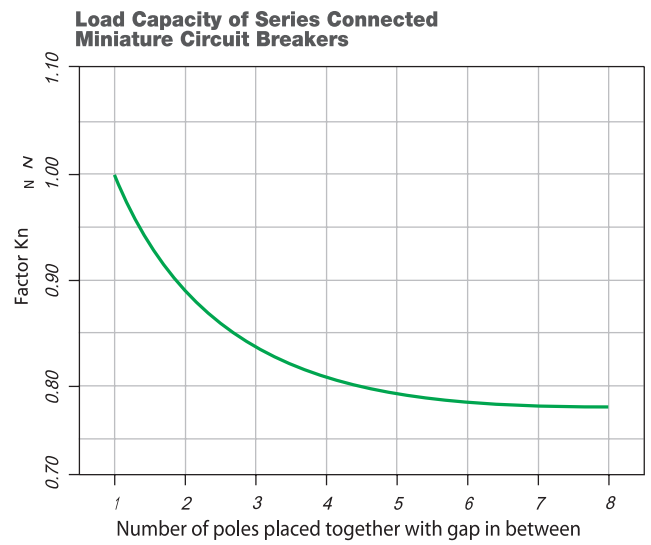

Let-through Energy 10kA

Let-through energy 10kA, characteristic B, 1-pole

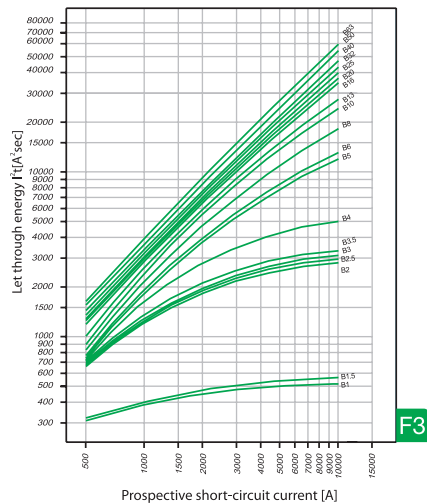

Let-through energy 10kA, characteristic C, 1-pole

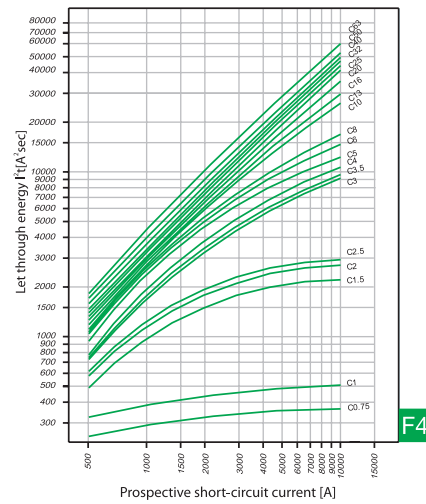

Let-through energy 10kA, characteristic D, 1-pole

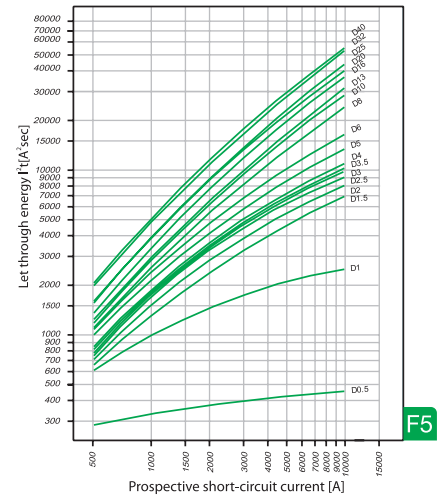

Isolator



- Available in single break & double break
- Contact position indicator red / green
- Secure terminal connection
- 3-position DIN rail clip, permits removal from existing busbar system
- Comprehensive range of accessories suitable for subsequent installation
- Rated currents 40A - 125A
- Rated conditional short circuit capacity 10 kA according to IS/IEC 60947-3
- IP20 degree of protection

Connection diagrams Isolator

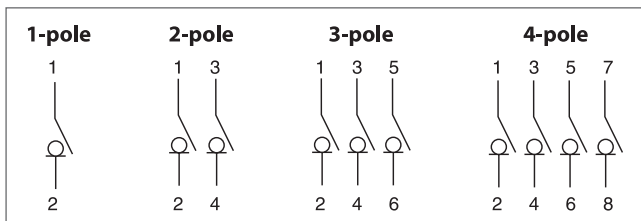

Single Break

Dimensions (mm)

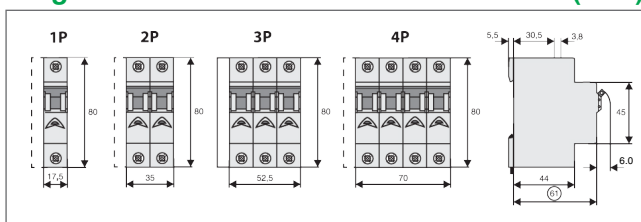

all dimension are in mm.

Mechanical

Frame size	45 mm
Device height	80 mm
Device width	17.5 mm per pole (1MU)
Mounting	quick fastening with 3 lock-in positions on DIN rail EN 50022
Degree of protection	IP20
Upper and lower terminals	open mouthed/lift terminals
Terminal protection	finger and hand touch safe,
Terminal capacity	1-35 mm ²
Terminal fastening torque	2-2.4 Nm
Busbar thickness	0.8 - 2 mm
Mounting	independent of position

Electrical

Reference Standard	IS/IEC 60947-3
No. of Poles	1P,2P,3P,4P
Utilization Category	AC 22B, AC 23B
Rated Current (In)	40A, 63A, 80A, 100A, 125A
Rated Voltage (Ue)	240/415 V ~
Rated Frequency (f)	50 Hz
Rated Insulation Voltage (Ui)	660V
Rated Impulse Voltage (Uimp)	6kV
Dielectric Strength	2.5kV
Electrical/Mechanical Endurance (no. of operations) minimum	Electrical : 1500 Mechanical : 8500
Humidity	95% RH
Terminal Capacity (max)	35mm ²
Tightening Torque	2 N-m
Vibration	3 g
Shock Resistance	40mm free fall
Protection Class	IP20
Positive Contact Indication	Yes, Through Flag Indication (Red-ON, Green-OFF)
Mounting	Clip on DIN Rail (35mm x 7.5mm)
Installation Position	Vertical/Horizontal
Case & Cover	Moulded, flame retardant PBT/Nylon
Busbar Connections Top Side	Pin/Fork Type
Busbar Connections Bottom Side	Pin/Fork Type



MCB Changeover Switch

- Conforms to IS/IEC : 60947-3
- Choice of Two Pole & Four Pole versions
- Front operation with three stable positions I-0-II
- Off at middle position
- DIN Rail Mounting facility

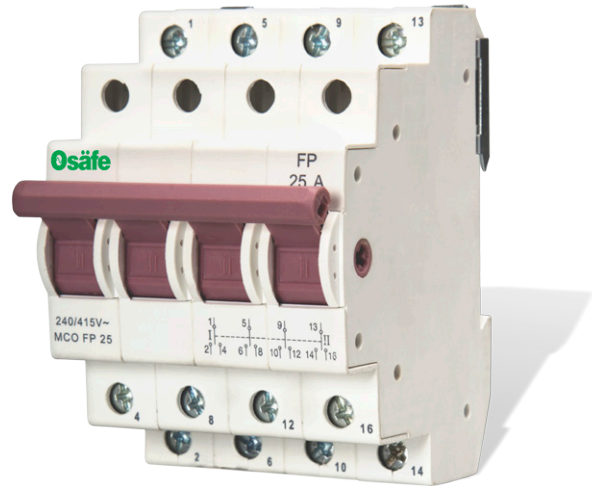

Connection Diagrams / Technical Marking

Two Pole

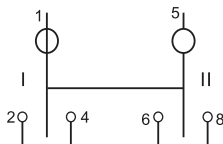

- | | | |
|------|-------------------------------------|-------|
| "I" | Incoming Terminals (Main Supply) | 2 & 6 |
| "II" | Incoming Terminals (Standby Supply) | 4 & 8 |
| | Outgoing Terminals (to load) | 1 & 5 |
- Mid position of knob is 'OFF' position

Four Pole

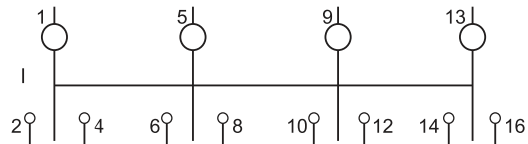

- | | | |
|------|-------------------------------------|---------------|
| "I" | Incoming Terminals (Main Supply) | 2, 6, 10 & 14 |
| "II" | Incoming Terminals (Standby Supply) | 4, 8, 12 & 16 |
| | Outgoing Terminals (to load) | 1, 5, 9 & 13 |
- Mid position of knob is 'OFF' position

Range



Double Pole MCB



Four Pole MCB

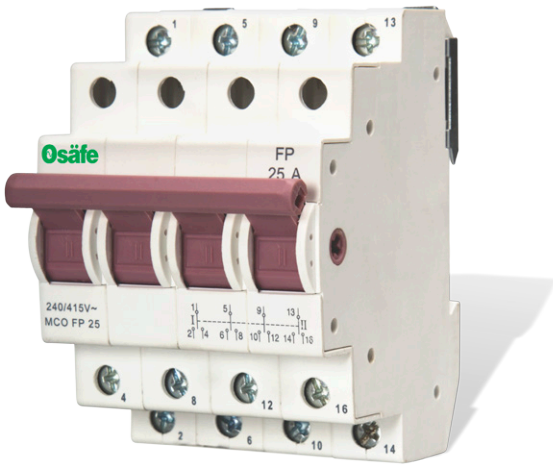

Standard Conformity	:	IS/IEC 60947 - 3
No. of Poles (Execution)	:	2 Pole, 4 Pole
Rated Current (In)	A	: 25A, 40A, 63A
Rated Voltage (Ue)	V	: 240 AC/415 AC
Rated Frequency	Hz	: 50
Rated Insulation Voltage	V	: 660
Dielectric Strength	kV	: 2.5
Rated Impulse Voltage	kV	: 4
Utilization Category	:	AC 22 A
Ambient Temp.	°C	: -5 to +55
Mechanical Life	:	10000 operations
Electrical Life	:	1500 operations
Mounting	:	Standard (35 x 7.5) mm - DIN Rail
Mounting Position	:	Vertical / Horizontal
Terminal Capacity	mm ²	: 35
Weight - Double Pole	gms	: 134
Four Pole	gms	: 268

Dimension (in mm)

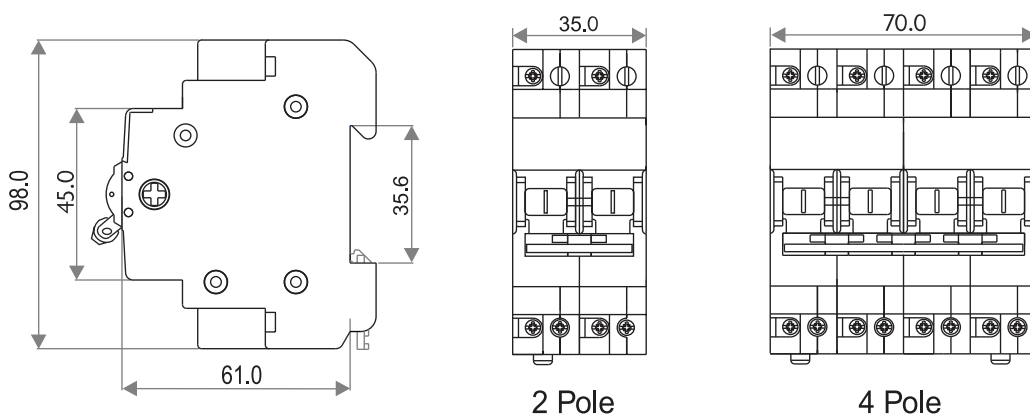



Residual Current Circuit Breaker

- Tested as per IEC 61008-1, IS 12640-1,
- Dedicated Earth leakage protection.
- Short Circuit Withstand capacity 10 kA
- In Double Pole & Four Pole version
- Protection against Electrocution, Short Circuit & Electrical Fire.
- Range: 25 Amp, 40 Amp, 63Amp & 80 Amp in 30mA, 100mA & 300mA
- Consistent performance, Compact & Space Saving
- Wide variety of nominal current.
- Automatic re-setting possible.



Connection Diagrams

2 Pole

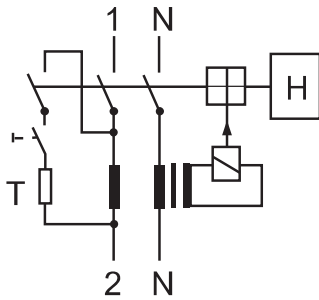

4 Pole

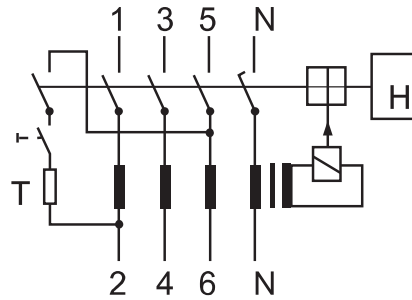

Range



Double Pole
RCCB



Four Pole
RCCB



Test Switch



Contact position flag indicator

Description

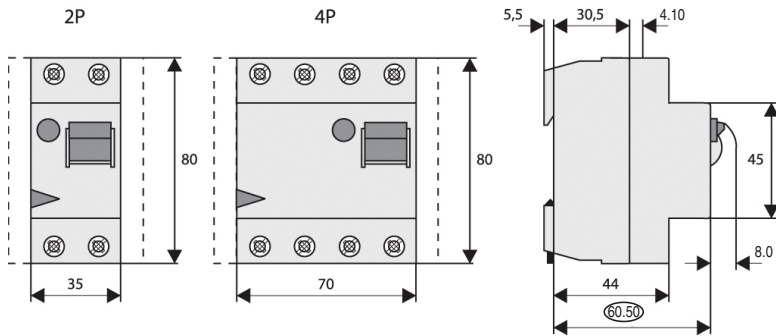

Electrical

Rated voltage	230 / 400V; 50 Hz
Sensitivity/Rated 30, 100, 300 mA	Leakage tripping current
Rated Conditional short circuit strength	10kA with 63 A gG back-up fuse 10kA with 80 A gG
Maximum back-up fuse for short circuit protection	63 A gG 80 A gG
Maximum back-up fuse for overload protection	25 A gG 40 A gG 50 A gG
Endurance electrical mechanical	> 4,000 operations

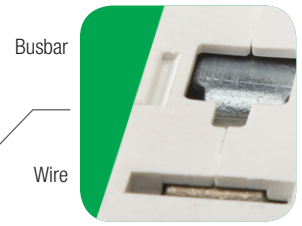

Cable Termination upto 35mm² Cable



3 Position Mounting Clip
Permits installation and removal without removing busbar.



Residual Current Protection Unit

- Add-on residual current unit
- Line voltage-independent tripping
- By combining this device with a miniature circuit breaker a top-quality RCBO unit (combined RCD/MCB device) is formed.
- Rated current 16 and 63 A
- Permits combinations with a variety of characteristics thanks to the different rated currents and characteristics of the miniature circuit breakers which can be connected
- Comprehensive range of accessories suitable for subsequent installation onto PLS.
- The test key "T" must be pressed every 6 month. The system operator must be informed of this obligation and his responsibility in a way that can be proven (self-adhesive RCD-label enclosed). The test intervall of 6 month is valid for residential and similar applications. Under all other conditions (e.g. damply or dusty environments), it's recommended to test in shorter intervalls (e.g. monthly).
- Pressing the test key "T" serves the only purpose of function testing the residual current device (RCD). This test does not make earthing resistance measurement (RE), or proper checking of the earth conductor condition redundant, which must be performed separately.
- **Type - A** : Protect against special forms of residual pulsating DC which have not been smoothed.
- **Type - G** : High reliability against unwanted tripping. Compulsory for any circuit where personal injury or damage to property may occur in case of unwanted tripping (ÖVE-EN1, Part1, §12.14).
- **Type - S** : Selective residual current device, either sensitive to AC, type -S, or sensitive to pulsating DC, type -S/A, for protection against special forms of residual pulsating DC which have not been smoothed. Compulsory for systems with surge arresters downstream of the RCD (ÖVE-EN1, Part 1, §12.15).



Accessories :

- Cover cap for draw-out connection bar
- Slotted one-way cheese head screw

Accessories (on PLS.) :

Auxiliary switch for	included
subsequent installation	ZP-IHK
	ZP-WHK
Tripping signal contact for	
subsequent installation	ZP-NHK
Remote control and automatic switching device	Z-FW/LP
Shunt trip release	ZP-ASA..
Undervoltage release	Z-USA..
Compact enclosure	KLV-TC-2
	KLV-TC-4
Additional terminal 35mm ²	Z-HA-EK/35
Switching interlock	IS/SPE-1TE

Connection diagramms

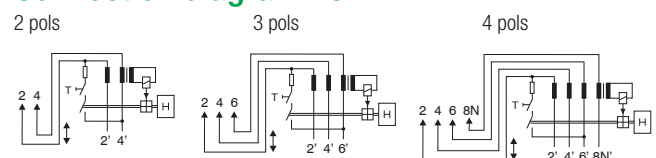

Technical Data

Electrical		Mechanical	
Design according to	IEC/EN 61009	Frame-size	45 mm
Current test marks as printed onto the device		Device height	90 mm
Tripping	instantaneous 250A (8/20 μ s), surge current-proof	Device width	70 mm (2p), 107.5 mm (3p), 125 mm (4p)
Type G	10 ms delay 3kA (8/20 μ s), surge current-proof	Mounting	fix mounted onto PLS.
Type S	40 ms delay 6kA - with selective disconnecting function]	Degree of protection installed device	IP20
Rated voltage U_n	230/400 V AC	Fastening screw	M 2.5 (slotted one-way cheese head screw;
Operational voltage range	196 - 440 V	Screw head breaking torque	> 0.6 Nm
Rated frequency	50 Hz	Upper and lower terminals	lift terminals
Use at 16 ^{2/3} Hz	Recesses time between the single switchings increases to 88 s, I_n max. 63A	Terminal screws	M 5 (combined Philips/standard head screws according to DIN7962-Z2, Pozidrive)
Use at 400 Hz	I_n max. 40 A	Terminal protection	finger and hand touch safe, BGV A3, ÖVE-EN 6
Rated current I_n	≤ 40 A, ≤ 63 A	Terminal capacity	
Rated tripping current $I_{\Delta n}$	30, 100, 300mA	Rigid conductors	1 x (1 - 25) mm ²
Rated non-tripping current $I_{\Delta no}$	0.5 $I_{\Delta n}$	Flexible conductors (with wire end sleeve)	1 x (0.75 - 16) mm ²
Sensitivity	AC and pulsating DC	Busbar thickness	0.8 - 2 mm
Service short circuit breaking capacity I_{cs}	same as connected PLS. (7.5 kA)	Permitted ambient temperature range	-25°C to +40°C
Rated breaking capacity I_{cn}	same as connected PLS. (10 kA)	Resistance to climatic conditions	acc. to IEC/EN 60068-2 (25..55°C/90..95% relative humidity)
Rated fault breaking capacity $I_{\Delta m}$	6 kA ($U_n = 230V$) 3 kA ($U_n = 400V$)	Rated fault breaking capacity $I_{\Delta m}$	6 kA ($U_n = 230V$) 3 kA ($U_n = 400V$)

Connection diagrams

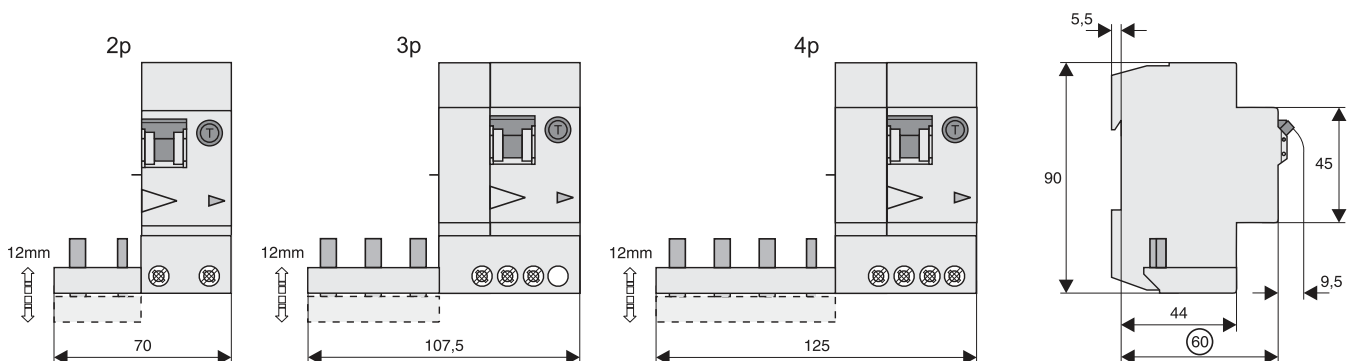



Combined RCD/MCB Devices, 1+N-pole

- Combined RCD/MCB device
- Line voltage-independent tripping
- Compatible with standard busbar
- Twin-purpose terminal (lift/open-mouthed) above and below
- Busbar positioning optionally above or below
- Free terminal space despite installed busbar
- Guide for secure terminal connection
- Switching toggle (MCB component) in colour designating the rated current
- Contact position indicator red - green
- Comprehensive range of accessories suitable for subsequent installation
- The test key "T" must be pressed every 6 month. The system operator must be informed of this obligation and his responsibility in a way that can be proven (self-adhesive RCD-label enclosed). The test intervall of 6 month is valid for residential and similar applications. Under all other conditions (e.g. damply or dusty environments), it's recommended to test in shorter intervalls (e.g. monthly).
- Pressing the test key "T" serves the only purpose of function testing the residual current device (RCD). This test does not make earthing resistance measurement (RE), or proper checking of the earth conductor condition redundant, which must be performed separately.
- **Type -A** : Protects against special forms of residual pulsating DC which have have not been smoothed
- **Type -G** : 10 ms time delay in order to avoid unwanted tripping (e.g. during thunderstorms).

Compulsory in Austria for any circuit where personal injury or damage to property may occur in case of unwanted tripping (§12.1.6 ÖVE/ÖNORM E 8001-1).



Accessories:

Auxiliary switch for subsequent installation	ZP-IHK
	ZP-WHK
Tripping signal switch for subsequent installation	ZP-NHK
Shunt trip release	ZP-ASA/..
Tripping module	Z-KAM
Terminal cover cap	KLV-TC-2
Additional terminal 35mm2	Z-HA-EK/35
Switching interlock	IS/SPE-1TE

Connection diagramms

1+N poles

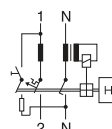

Technical Data

Electrical		Mechanical	
Design according to	IEC/EN 61009	Frame size	45 mm
Current test marks as printed onto the device		Device height	80 mm
Tripping line voltage-independent	instantaneous 250A (8/20 μ s) surge current-proof;	Device width	35 mm (2MU)
Type G	10 ms delay 3kA (8/20 μ s) surge current-proof	Mounting	3-position DIN rail clip, permits removal from existing busbar system
Rated voltage U_e	230 V; 50 Hz	Upper and lower terminals	open mouthed/lift terminals
Operational voltage range	196-253 V	Terminal protection	finger and hand touch safe, BGV A3, ÖVE-EN 6
Rated tripping current $I_{\Delta n}$	30, 100, 300 mA	Terminal capacity	1 - 25 mm ²
Rated non-tripping current $I_{\Delta no}$	0.5 $I_{\Delta n}$	Busbar thickness	0.8 - 2 mm
Rated insulation voltage U_i	440 VAC	Degree of protection switch	IP20
Sensitivity	AC and pulsating DC	Degree of protection, built-in	IP40
Selectivity class	3	Tripping temperature	-25°C to +40°C
Rated breaking capacity	10 kA	Storage- and transport temperature	-35°C to +60°C
Rated current	16 - 40 A	Resistance to climatic conditions	acc. to IEC/EN 61009
Rated peak withstand voltage U_{imp}	4 kV (1.2/50 μ s)	Rated peak withstand voltage U_{imp}	4 kV (1.2/50 μ s)
Characteristic	B, C	Characteristic	B, C
Maximum back-up fuse (short circuit)	100 A gL (>10 kA)	Maximum back-up fuse (short circuit)	100 A gL (>10 kA)
Endurance electrical comp.	$\geq 4,000$ operating cycles	Endurance electrical comp.	$\geq 4,000$ operating cycles
Mechanical comp.	$\geq 20,000$ operating cycles	Mechanical comp.	$\geq 20,000$ operating cycles

Connection diagrams

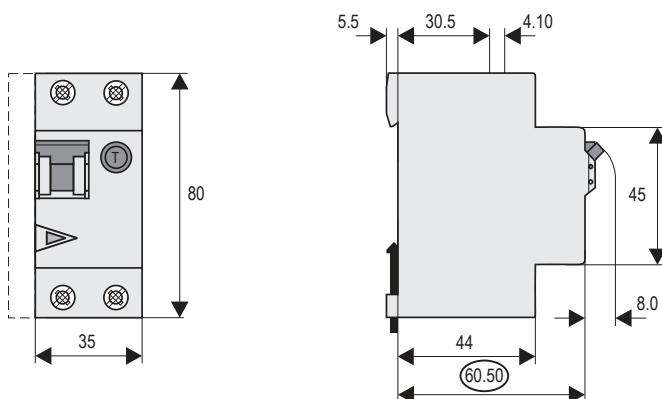



Load Capacity -1N/

Effect of ambient temperature (MCB component)

I _n [A]	Ambient temperature T [°C]								
	-25	-20	-10	0	10	20	30	35	40
2	2.5	2.4	2.3	2.2	2.2	2.1	2.0	2.0	1.9
4	4.9	4.8	4.7	4.5	4.3	4.2	4.0	3.9	3.9
5	6.2	6.0	5.8	5.6	5.4	5.2	5.0	4.9	4.8
6	7.4	7.2	7.0	6.7	6.5	6.3	6.0	5.9	5.8
8	9.9	9.6	9.3	9.0	8.7	8.4	8.0	7.9	7.7
10	12	12	12	11	11	10	10	9.9	9.7
12	15	14	14	13	13	13	12	12	12
13	16	16	15	15	14	14	13	13	13
15	19	18	17	17	16	16	15	15	15
16	20	19	19	18	17	17	16	16	15
20	25	24	23	22	22	21	20	20	19
25	31	30	29	28	27	26	25	25	24
32	40	38	37	36	35	33	32	32	31
40	49	48	47	45	43	42	40	39	39

Tripping Characteristic -1N/, Characteristics B a. C

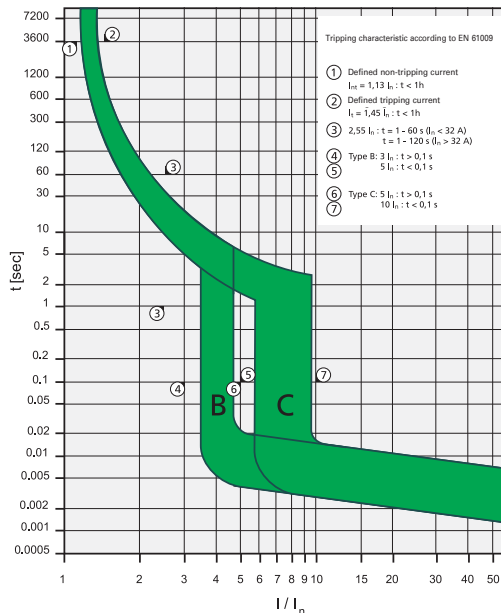

Short Circuit Selectivity -1N/ towards DII-DIV fuse link

In case of short circuit, there is selectivity between the combined RCD/MCB devices 1N/ and the upstream fuses up to the specified values of the selectivity limit current I_s [kA] (i. e. in case of short-circuit currents I_{sc} under I_s, only the MCB will trip, in case of short circuit currents above this value both protective devices will respond).

*) basically in accordance with EN 60898-1 D.5.2.b

Short circuit selectivity characteristic B towards fuse link DII-DIV *)

Rating	DII-DIV gL/gG									
I _n [A]	10	16	20	25	35	50	63	80	100	
2	<0.5 ¹⁾	<0.5 ¹⁾	2.2	8.5	10.0 ²⁾	10.0 ²⁾	10.0 ²⁾	10.0 ²⁾	10.0 ²⁾	10.0 ²⁾
4	<0.5 ¹⁾	<0.5 ¹⁾	0.7	1.2	3.7	10.0	10.0 ²⁾	10.0 ²⁾	10.0 ²⁾	10.0 ²⁾
6		<0.5 ¹⁾	0.7	1.0	2.9	6.9	10.0 ²⁾	10.0 ²⁾	10.0 ²⁾	10.0 ²⁾
8		<0.5 ¹⁾	0.6	1.0	2.4	5.1	10.0 ²⁾	10.0 ²⁾	10.0 ²⁾	10.0 ²⁾
10			0.6	0.9	1.9	3.3	7.0	10.0 ²⁾	10.0 ²⁾	10.0 ²⁾
13			0.5	0.7	1.6	2.8	5.7	9.0	10.0 ²⁾	10.0 ²⁾
16				0.7	1.4	2.4	4.4	7.0	10.0 ²⁾	10.0 ²⁾
20					1.3	2.2	4.0	6.3	10.0 ²⁾	10.0 ²⁾
25					1.3	2.1	3.8	5.8	10.0 ²⁾	10.0 ²⁾
32						2.0	3.5	5.2	9.5	10.0 ²⁾
40							3.1	4.5	8.1	10.0 ²⁾

Short circuit selectivity characteristic C towards fuse link DII-DIV *)

Rating	DII-DIV gL/gG									
I _n [A]	10	16	20	25	35	50	63	80	100	
2	<0.5 ¹⁾	<0.5 ¹⁾	1.7	6.0	10.0 ²⁾	10.0 ²⁾	10.0 ²⁾	10.0 ²⁾	10.0 ²⁾	10.0 ²⁾
4	<0.5 ¹⁾	<0.5 ¹⁾	0.7	1.3	4.2	8.5	10.0 ²⁾	10.0 ²⁾	10.0 ²⁾	10.0 ²⁾
5	<0.5 ¹⁾	<0.5 ¹⁾	0.6	1.1	3.6	7.0	10.0 ²⁾	10.0 ²⁾	10.0 ²⁾	10.0 ²⁾
6		<0.5 ¹⁾	0.6	1.0	2.9	5.8	10.0 ²⁾	10.0 ²⁾	10.0 ²⁾	10.0 ²⁾
8		<0.5 ¹⁾	<0.5	0.9	2.5	4.8	10.0 ²⁾	10.0 ²⁾	10.0 ²⁾	10.0 ²⁾
10			<0.5	0.7	1.5	2.6	5.3	9.0	10.0 ²⁾	10.0 ²⁾
13				1.4	2.3	4.6	7.6	10.0 ²⁾	10.0 ²⁾	10.0 ²⁾
16				1.2	1.8	3.4	5.5	10.0 ²⁾	10.0 ²⁾	10.0 ²⁾
20				1.2	1.7	3.1	5.0	10.0 ²⁾	10.0 ²⁾	10.0 ²⁾
25					1.6	2.9	4.6	10.0 ²⁾	10.0 ²⁾	10.0 ²⁾
32						2.3	3.4	7.7	10.0 ²⁾	10.0 ²⁾
40							2.9	6.2	10.0 ²⁾	10.0 ²⁾

¹⁾ Selectivity limit current I_s under 0.5 kA

²⁾ Selectivity limit current I_s = rated breaking capacity I_{cn} of the RCD/MCB device

Darker areas: no selectivity



Protective Devices

Short Circuit Selectivity-1N/ towards D01-D03 fuse link

In case of short circuit, there is selectivity between the combined RCD/MCB devices 1N/ and the upstream fuses up to the specified values of the selectivity limit current I_s [kA] (i. e. in case of short-circuit currents I_{sc} under I_s , only the MCB will trip, in case of short circuit currents above this value both protective devices will respond).

*) basically in accordance with EN 60898-1 D.5.2.b

Short circuit selectivity characteristic B towards fuse link D01-D03 *)

Rating	D01-D03 gL/gG									
I_n [A]	10	16	20	25	35	50	63	80	100	100
2	<0.5 ¹⁾	0.7	1.6	3.3	10.0 ²⁾	10.0 ²⁾	10.0 ²⁾	10.0 ²⁾	10.0 ²⁾	10.0 ²⁾
4	<0.5 ¹⁾	<0.5 ¹⁾	0.6	0.9	2.9	10.0	10.0 ²⁾	10.0 ²⁾	10.0 ²⁾	10.0 ²⁾
6		<0.5 ¹⁾	0.5	0.8	2.4	8.2	10.0 ²⁾	10.0 ²⁾	10.0 ²⁾	10.0 ²⁾
8			0.6	0.8	2.0	6.0	10.0 ²⁾	10.0 ²⁾	10.0 ²⁾	10.0 ²⁾
10			0.5	0.8	1.6	3.7	6.0	10.0 ²⁾	10.0 ²⁾	10.0 ²⁾
13			0.6	0.7	1.4	3.0	4.7	9.0	10.0 ²⁾	10.0 ²⁾
16				0.6	1.2	2.6	3.9	7.0	10.0 ²⁾	10.0 ²⁾
20					1.2	2.5	3.6	6.2	10.0 ²⁾	10.0 ²⁾
25					1.2	2.3	3.3	5.7	10.0 ²⁾	10.0 ²⁾
32						2.3	3.1	5.1	10.0 ²⁾	10.0 ²⁾
40							2.8	4.5	9.5	10.0 ²⁾

Short circuit selectivity characteristic C towards fuse link D01-D03 *)

Rating	D01-D03 gL/gG									
I_n [A]	10	16	20	25	35	50	63	80	100	100
2	<0.5 ¹⁾	0.5	0.5	2.4	10.0 ²⁾	10.0 ²⁾	10.0 ²⁾	10.0 ²⁾	10.0 ²⁾	10.0 ²⁾
4	<0.5 ¹⁾	<0.5 ¹⁾	<0.5 ¹⁾	0.9	3.4	9.5	10.0 ²⁾	10.0 ²⁾	10.0 ²⁾	10.0 ²⁾
5	<0.5 ¹⁾	<0.5 ¹⁾	<0.5 ¹⁾	0.9	2.9	8.0	10.0 ²⁾	10.0 ²⁾	10.0 ²⁾	10.0 ²⁾
6		<0.5 ¹⁾	<0.5 ¹⁾	0.8	2.3	6.5	10.0 ²⁾	10.0 ²⁾	10.0 ²⁾	10.0 ²⁾
8			<0.5	0.7	2.1	5.5	9.5	10.0 ²⁾	10.0 ²⁾	10.0 ²⁾
10			<0.5	0.6	1.3	2.9	4.5	8.9	10.0 ²⁾	10.0 ²⁾
13					1.2	2.5	3.9	7.6	10.0 ²⁾	10.0 ²⁾
16					1.0	2.1	3.0	5.5	10.0 ²⁾	10.0 ²⁾
20					1.0	2.0	2.7	5.0	10.0 ²⁾	10.0 ²⁾
25						1.9	2.6	4.5	10.0 ²⁾	10.0 ²⁾
32							2.1	3.4	10.0 ²⁾	10.0 ²⁾
40								3.0	8.7	10.0 ²⁾

Short Circuit Selectivity -1N/ towards NH-00 fuse link

In case of short circuit, there is selectivity between the combined RCD/MCB devices 1N/ and the upstream fuses up to the specified values of the selectivity limit current I_s [kA] (i. e. in case of short-circuit currents I_{sc} under I_s , only the MCB will trip, in case of short circuit currents above this value both protective devices will respond).

*) basically in accordance with EN 60898-1 D.5.2.b

Short circuit selectivity characteristic B towards fuse link NH-00 *)

Rating	NH-00 gL/gG												
I_n [A]	16	20	25	32	35	40	50	63	80	100	125	160	
2	<0.5 ¹⁾	1.1	3.6	10.0 ²⁾	10.0 ²⁾	10.0 ²⁾	10.0 ²⁾	10.0 ²⁾	10.0 ²⁾	10.0 ²⁾	10.0 ²⁾	10.0 ²⁾	
4	<0.5 ¹⁾	0.5	0.9	1.6	2.8	4.4	10.0 ²⁾	10.0 ²⁾	10.0 ²⁾	10.0 ²⁾	10.0 ²⁾	10.0 ²⁾	
6	<0.5 ¹⁾	0.5	0.8	1.4	2.2	3.3	7.0	10.0 ²⁾	10.0 ²⁾	10.0 ²⁾	10.0 ²⁾	10.0 ²⁾	
8	<0.5 ¹⁾	<0.5 ¹⁾	0.7	1.0	1.9	2.8	5.3	7.8	10.0 ²⁾	10.0 ²⁾	10.0 ²⁾	10.0 ²⁾	
10		<0.5 ¹⁾	0.7	0.9	1.5	2.1	3.4	4.3	7.3	10.0 ²⁾	10.0 ²⁾	10.0 ²⁾	
13		<0.5 ¹⁾	0.6	0.8	1.4	1.8	2.8	3.6	5.7	10.0 ²⁾	10.0 ²⁾	10.0 ²⁾	
16			0.6	0.7	1.2	1.5	2.4	3.0	4.5	10.0 ²⁾	10.0 ²⁾	10.0 ²⁾	
20				0.7	1.1	1.5	2.2	2.8	4.2	9.2	10.0 ²⁾	10.0 ²⁾	
25				0.7	1.1	1.4	2.1	2.6	4.0	8.2	10.0 ²⁾	10.0 ²⁾	
32					1.0	1.4	2.0	2.5	3.7	7.1	10.0 ²⁾	10.0 ²⁾	
40							2.3	3.4	6.2	8.8	10.0 ²⁾	10.0 ²⁾	

Short circuit selectivity characteristic C towards fuse link NH-00 *)

Rating	NH-00 gL/gG												
I_n [A]	16	20	25	32	35	40	50	63	80	100	125	160	
2	<0.5 ¹⁾	0.6	2.6	10.0 ²⁾	10.0 ²⁾	10.0 ²⁾	10.0 ²⁾	10.0 ²⁾	10.0 ²⁾	10.0 ²⁾	10.0 ²⁾	10.0 ²⁾	
4	<0.5 ¹⁾	<0.5 ¹⁾	0.9	1.8	3.2	4.8	8.7	10.0 ²⁾	10.0 ²⁾	10.0 ²⁾	10.0 ²⁾	10.0 ²⁾	
5	<0.5 ¹⁾	<0.5 ¹⁾	0.8	1.6	2.7	4.1	7.2	9.7	10.0 ²⁾	10.0 ²⁾	10.0 ²⁾	10.0 ²⁾	
6	<0.5 ¹⁾	<0.5 ¹⁾	0.7	1.3	2.2	3.3	5.9	8.0	10.0 ²⁾	10.0 ²⁾	10.0 ²⁾	10.0 ²⁾	
8	<0.5 ¹⁾	<0.5 ¹⁾	0.6	1.1	1.9	2.8	5.0	6.7	10.0 ²⁾	10.0 ²⁾	10.0 ²⁾	10.0 ²⁾	
10			0.5	0.8	1.2	1.7	2.7	3.4	5.5	10.0 ²⁾	10.0 ²⁾	10.0 ²⁾	
13					1.1	1.5	2.3	2.9	4.7	10.0 ²⁾	10.0 ²⁾	10.0 ²⁾	
16					1.0	1.3	1.8	2.3	3.7	8.7	10.0 ²⁾	10.0 ²⁾	
20					0.9	1.1	1.7	2.2	3.4	8.0	10.0 ²⁾	10.0 ²⁾	
25						1.6	2.1	3.2	7.2	10.0 ²⁾	10.0 ²⁾	10.0 ²⁾	
32							1.7	2.6	5.3	9.0	10.0 ²⁾	10.0 ²⁾	
40								2.4	4.5	7.5	10.0 ²⁾	10.0 ²⁾	

¹⁾ Selectivity limit current I_s under 0.5 kA

²⁾ Selectivity limit current I_s = rated breaking capacity I_{cn} of the RCD/MCB device

Darker areas: no selectivity



Distribution Board

Wide Range-Varied Application



Wide Range-Varied Application

Osafe DB's are design to meet the requirement of today's Building Industry for domestic, commercial & Industrial application.

Osafe DB's are aesthetically designed it cover all functionality & Safety norms to meets high standard of quality.

Our Distribution boards are manufactured with high precision & High Quality CRCA Steel Sheets. Its finest process of Phosphatizing ensure anti-rust conditioning with better finish.

Osafe is available in elegant white colour. (RAL9003) Osafe Distribution boards are as per IP 43 Protection with metal door.

Knockout for SPN & TPN DB's (26mm & 32mm).

Detachable Plate on Top and Bottom in case of higher conduits.



Range





Shrouded Neutral Bar



Detachable Pan Assembly

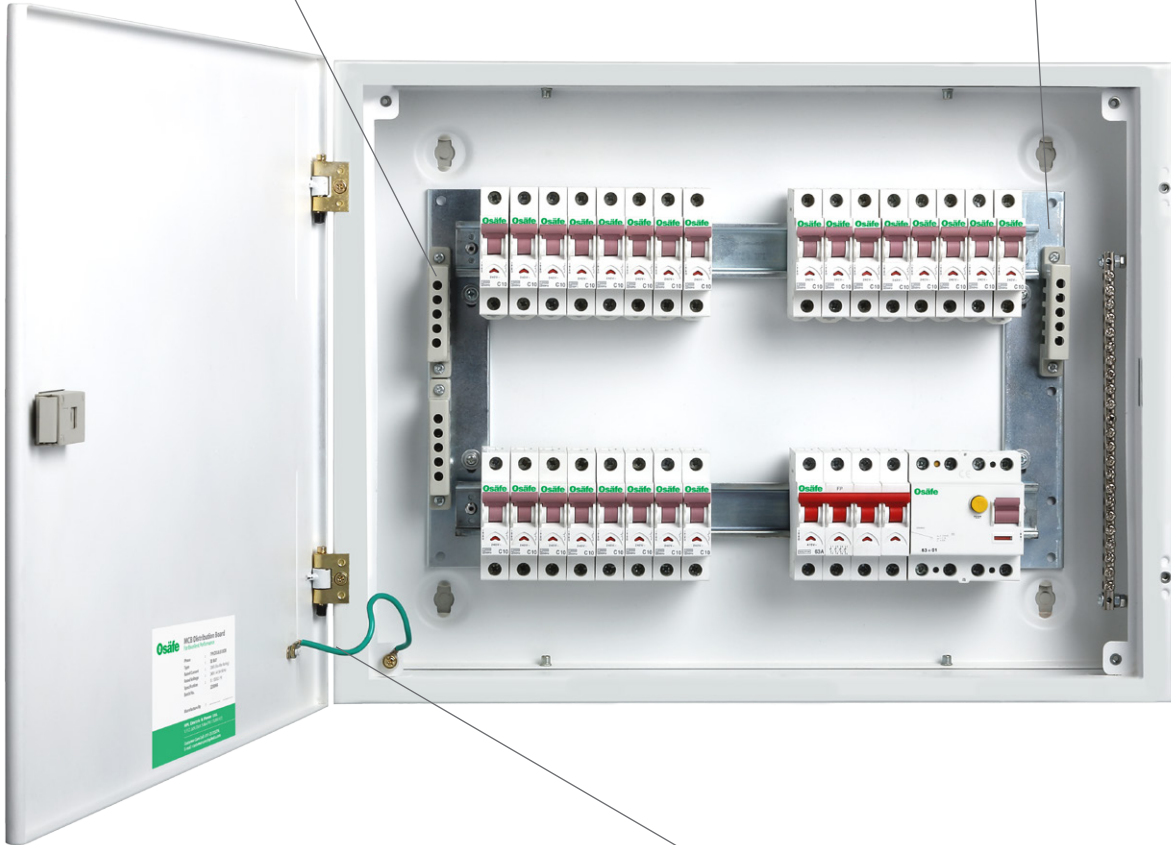

Door Earthing

Major Features

- Color white (RAL9003)
- As per IS 8623
- Cement Guard
- Anti Insertion Marker
- Shrouded neutral bar & insulated copper bus bar.
- Door Earthing
- Suitable for flash & Surface Mounting.
- As per IP-43 Protection

Distribution Board

Wide Range-Varied Application

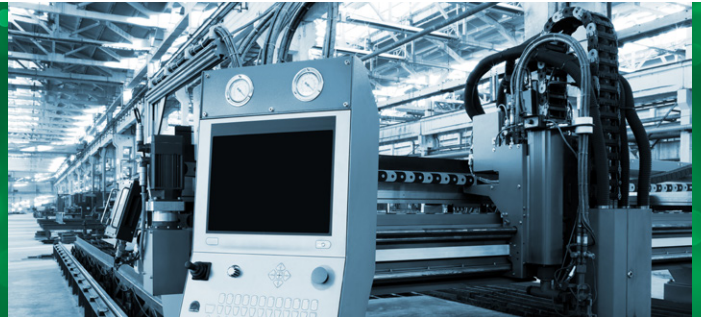

SPN DB Sailable Features

- Suitable for flush mounting & surface mounting.
- Insulated Bus bar rated upto 200A.
- Safe Neutral link covered with FR Housing
- Door Earthing
- PAN Assy for ease of installation.
- Special care of Cable Management
- Sunpack sheet
- Mat finish with new look & New Innovative DB

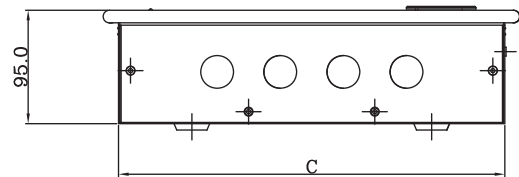
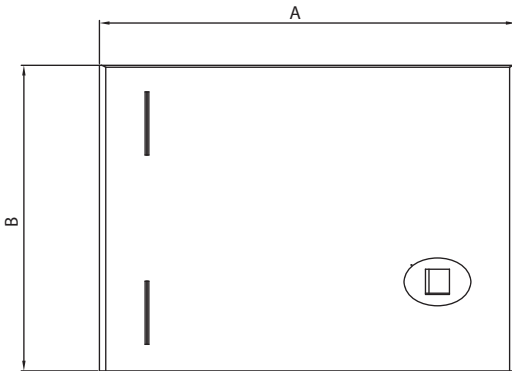

Ways	A	B	C
4	220.00	226.00	196.00
6	255.00	226.00	231.00
8	290.00	226.00	266.00
10	325.00	226.00	301.00
12	360.00	226.00	336.00
14	395.00	226.00	371.00
16	430.00	226.00	406.00

TPN DB Slient Features

- Suitable for flush mounting & surface mounting.
- Insulated Bus bar rated upto 200A.
- Safe Neutral link covered with FR Housing
- Door Earthing
- Equipped with wire set
- Provision for FPMCB/Isolator & FP RCCB as Incommer
- PAN Assy for ease of installation.
- Special care of Cable Management
- Sunpack sheet
- Mat finish with new look & New Innovative DB



Standard accessories

- Wire Set
- Insulated bus bar
- Insulated neutral bars & Earth Bar
- Blanking Plates
- Wire Management System
- Circuits identification Labels

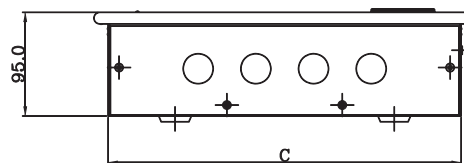
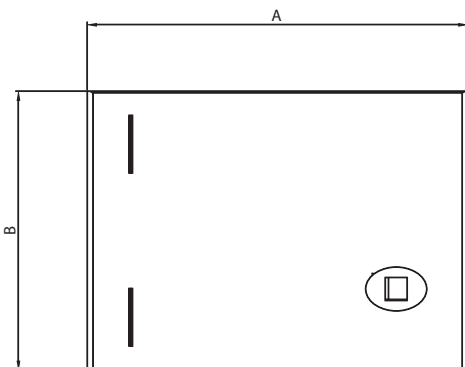

Ways	A	B	C
4	438.00	400.00	412.00
6	473.00	400.00	447.00
8	543.00	400.00	517.00
12	688.00	400.00	657.00

Branch Offices:

AHMEDABAD

B-802, Iscon Elegance, Nr. Prahlad Nagar Corner, Opp. Karnavati Club, S.G. Highway, Ahmedabad-380 051
Ph.: 079 - 66168835
E-mail: ahmedabad@hplindia.com

BANGALORE

No.2D, IInd Floor, Farah Winsford, 133, Infantry Road, Bangalore - 560 001
Ph.: 080-22863068/69
E-mail: bangalore@hplindia.com

BHUBANESWAR

N3-135, IRC Village, Nayabali, Behind Old Sai Baba Temple, Bhubaneswar-751 012 Ph.: 0674-2550826
E-mail: orissa@hplindia.com

CHANDIGARH

Plot No. 57, 5th Floor Industrial & Business Park, Phase-1 Chandigarh - 160002 Ph.: 0172-2639157
E-mail: chandigarh@hplindia.com

CHENNAI

"Amar Sindur" S-4, 2nd Floor, No.-43, Pantheon Road, Egmore, Chennai-600 008
Ph.: 044-28551530, 28551537
Fax : 044-42638243
E-mail: chennai@hplindia.com

COCHIN

2nd Floor, A.K.S. Mahal Building, XL/7813J, Achutha Warriar Lane, M.G.Road, Ernakulam, Cochin-682 035
Telefax : 0484-2354595
E-mail: cochin@hplindia.com

COIMBATORE

Designer Complex, Door No.130, C /2, 2nd Floor, Dr. Nanjappa Road, Coimbatore - 641018
Ph.:0422-4393995
E-mail : coimbatore@hplindia.com

DEHRADUN

09/4/6, 1st Floor, East Canal Road, (Near Doon Defence Academy) Dehradun-248001
Ph.: 0135-2710567, 2710587
E-mail: Uttranchal@hplindia.com

GUWAHATI

Rajgarh Road, Opposite China Town Restaurant Guwahati - 781 003
Ph.: 0361-2450889
E-mail: guwahati@hplindia.com

HUBLI

9-10, 1st Floor, Vernekar Plaza, Desh Pande Nagar, Hubli-580029
Ph.: 0836-4251463
E-mail : hubli@hplindia.com

HYDERABAD

No. 7-1-58, flat No.403, 4th Floor, Concourse Building, Green Lands Road, Hyderabad - 500 016
Ph.: 040-40035959
E-mail: hyderabad@hplindia.com

INDORE

203, Millinda Manor 2 RNT Marg, Near Ravindra Natya Grah, Indore- 452 001,
Ph.: 0731-4280525, 4225540
E-mail: Indore@hplindia.com

JAIPUR

512, 5th floor, Plot No. 8-9, Corporate Park, Gopal Bari, Ajmer Road Jaipur - 302 001
Ph. : 0141-4021035
E-Mail: jaipur@hplindia.com

JAMMU

Plot No.86 Yard No.6 Transport Nagar, Jammu- 180006
E-mail: jammu@hplindia.com

KANPUR

17/14, 2nd Floor, Opposite Nanarao Park, The Mall, Kanpur - 208 001 (U.P.)
Ph.: 0512-2316017
E-mail: kanpur@hplindia.com

KOLKATA

69, Ganesh Chandra Avenue, India House 7th Floor, Block-C, Kolkata - 700 013
Ph.: 033-65394379
E-Mail: calcutta@hplindia.com

LUCKNOW

1st Floor, Jain Building, 14/A5, Park Road Hazratganj ,Lucknow
Ph.: 0522-4021687
E-Mail: lucknow@hplindia.com

LUDHIANA

698 - D, Model Town, Extn., Opp. silverstone Hotel, Ludhiana-141 003
Ph. : 0161-4062877
E-Mail : ludhiana@hplindia.com

MUMBAI

2C/H, Rushabh Chambers 2nd Floor, Off-Makwana Road, Near Rubi Hotel Marol Andheri East Mumbai - 400 059
Ph.: 022-61830810-20 Telefax: 022-28528181
E-mail: mumbai@hplindia.com

NAGPUR

Jagtap House, Plot No. 07, 1st Floor, Ganesh Gruh Nirman Society, Near Ganesh Mandir, Ring Road, Pratap Nagar, Nagpur - 440022,
Ph.: 0712-2222988
E-mail: nagpur@hplindia.com

PATNA

Hem Plaza, 5th Floor - 510 Frazer Road, Patna - 800001(Bihar)
Ph. : 09334697299
E-mail: patna@hplindia.com

PUNE

Sunrise Skyline 3rd Floor, Plot No. 28/2 Scheme No. 11 B Opp. MSEB Office Somwar Peth Pune - 411 001 Ph. : 020-69200902
E-mail: pune@hplindia.com

RAIPUR

1st Floor, Near Holy Heart School Chattisgarh College Road, Civil Line, Raipur (C.G.)-492 006 Ph.:0771-6541590
E-mail : raipur@hplindia.com

RANCHI

203, Mahalaxmi Complex, Line Tank Road, 2nd Floor Ranchi - 834 001
Telefax : 0651-2206144
E-mail : ranchi@hplindia.com

SILIGURI

1st Floor, Parasuna Bhawan, Ward No.13, Udhham Singh Sarani, Asram Para, Siliguri-734001

VADODARA

409/410, Silver Oak Complex, Near Sainik Park Char Rasta, Productivity Road, Akota, Vadodara - 390020 Gujarat
Ph.: 0265-2341747 Fax:0265-2352107
E-mail : baroda@hplindia.com

VIJAYAWADA

D.No.-29-37-135, 2nd Floor, G. R. Plaza, Eluru Road, Beside Canara Bank, Vijayawada-520 002
Ph.: 0866-6622291
E-mail : vijayawada@hplindia.com

VIZAG

B.K. Towers, 49-34-1/63, 3rd Floor Akka Yyapalem Main Road, NH-5 Junction, Vizag-530 016 (A.P.)
Ph.: 0891-2794506
E-mail : vizag@hplindia.com

Resident Offices:

Agartala	Balasure	Davangere	Jharsuguda	Moradabad	Silchar	Vapi
Agra	Belgaum	Durg	Jodhpur	Mysore	Surat	Varanasi
Allahabad	Berhampur	Goa	Kanyakumari	Nagercoil	Sholapur	Vellore
Anantpuram	Bhilai	Gorakhpur	Kolhapur	Nasik	Srinagar	
Aurangabad	Bhopal	Gulbarga	Kota	Patiala	Sambalpur	
Amravati	Bilaspur	Jabalpur	Madurai	Pondicherry	Tirupati	
Akola	Bijapur	Jabli	Malda	Rajkot	Trichy	
Angul	Calicut	Jamshedpur	Mangalore	Rourkela	Trivandrum	
Bareilly	Cuttack	Jalandhar	Meerut	Salem	Udaipur	

Works:

- Gurgaon - Haryana
- Sonapat - Haryana
- Kundli - Haryana
- Karnal - Haryana
- Jabli - Himachal Pradesh



HPL Electric & Power Ltd

Corp. Office : Windsor Business Park, B-1D, Sector-10, Noida, U.P. - 201301, INDIA. | Tel.: +91-120-4656300
Registered Office : 1/21, Asaf Ali Road, New Delhi - 110 002, INDIA.
E-mail : hpl@hplindia.com; enquiry@hplindia.com

Customer Care No. :
18004190198

www.hplindia.com