

Branch Offices:

AHMEDABAD

B-802, Iscon Elegance, Nr. Prahlad Nagar Corner, Opp. Karnavati Club, S.G. Highway, Ahmedabad-380051
Ph.: 079 - 66168835/36
E-mail: ahmedabad@hplindia.com

BANGALORE

No.2D, IInd Floor, Farah Winsford, 133, Infantry Road, Bangalore - 560001
Ph.: 080-22863068/69
E-mail: bangalore@hplindia.com

BHUBANESWAR

N3-135, IRC Village, Nayabali, Behind Old Sai Baba Temple, Bhubaneswar-751012, Ph.: 0674-2550826
E-mail: orissa@hplindia.com

CHANDIGARH

SCO-14, 1st Floor, Industrial & Business Park, Phase-II, Chandigarh-160002
Ph.: 0172-2639157/ 8146404442
E-mail: chandigarh@hplindia.com

CHENNAI

"Amar Sindur" S-4, 2nd Floor, No.-43, Pantheon Road, Egmore, Chennai-600 008
Ph.: 044-28551530, 28551537
Fax: 044-42638243
E-mail: chennai@hplindia.com

COCHIN

1st Floor, A.K.S. Mahal Building, XL7813J, Achutha Warriar Lane, M.G.Road, Ernakulam, Cochin-682035
Telefax: 0484-2354595
E-mail: cochin@hplindia.com

COIMBATORE

Designer Complex, Door No.130, C/2, 2nd Floor, Dr. Nanjappa Road, Coimbatore - 641018
Ph.: 0422-4393995
E-mail: coimbatore@hplindia.com

DEHRADUN

09/4/6, 1st Floor, East Canal Road, (Near Doon Defence Academy) Dehradun-248001
Ph.: 0135-2710567, 2710587
E-mail: Uttranchal@hplindia.com

GUWAHATI

Rajgarh Road, Opposite China Town Restaurant, Guwahati-781003
Ph.: 0361-2450889
E-mail: guwahati@hplindia.com

HUBLI

9-10, 1st Floor, Vernekar Plaza, Desh Pande Nagar, Hubli-580029
Ph.: 0836-4251463
E-mail: hubli@hplindia.com

HYDERABAD

No. 7-1-58, Flat No.403, 4th Floor, Concourse Building, Green Lands Road, Hyderabad-500016
Ph.: 040-66687878
E-mail: hyderabad@hplindia.com

INDORE

203, Millinda Manor 2, RNT Marg, Near Ravindra Natya Grah, Indore-452001,
Ph.: 0731-4280525, 4225540
E-mail: Indore@hplindia.com

JAIPUR

512, 5th Floor, Plot No. 8-9, Corporate Park, Gopal Bari, Ajmer Road, Jaipur-302001
Ph.: 0141-4021035
E-Mail: jaipur@hplindia.com

JAMMU

Plot No.86, Yard No.6, Transport Nagar, Jammu-180006
E-mail: jammu@hplindia.com

KOLKATA

69, Ganesh Chandra Avenue, India House, 7th Floor, Block-C, Kolkata-700013
Ph.: +91 9038094379
E-Mail: calcutta@hplindia.com

LUCKNOW

1st Floor, Jain Building, 14/A5, Park Road Hazratganj, Lucknow-226001
Ph.: 0522-4021687
E-Mail: lucknow@hplindia.com

LUDHIANA

698 - D, Model Town Extn., Opp. Silverstone Hotel, Ludhiana-141003
Ph.: 0161-4062877
E-Mail: ludhiana@hplindia.com

MUMBAI

2C/H, Rushabh Chambers, 2nd Floor, Off-Makwana Road, Near Rubi Hotel, Marol, Andheri East, Mumbai-400059
E-mail: mumbai@hplindia.com

NAGPUR

Jagtap House, Plot No. 07, 1st Floor, Ganesh Gruh Nirman Society, Near Ganesh Mandir, Ring Road, Pratap Nagar, Nagpur-440022,
Ph.: 0712-2222988
E-mail: nagpur@hplindia.com

PATNA

Hem Plaza, 5th Floor - 510 Frazer Road, Patna-800001(Bihar)
Ph.: +91 9334697299
E-mail: patna@hplindia.com

PUNE

Sunrise Skyline 3rd Floor, Plot No. 28/2 Scheme No. 11 B Opp. MSEB Office Somwar Peth Pune-411001 Ph.: +91 9028032724
E-mail: pune@hplindia.com

RAIPUR

1st Floor, Near Holy Heart School Chattisgarh College Road, Civil Line, Raipur (C.G.)-492006 Ph.: 0771-4218002/04
E-mail: raipur@hplindia.com

RANCHI

203, 2nd Floor, Mahalaxmi Complex, Line Tank Road, Ranchi-834001
Telefax: 0651-2206144
E-mail: ranchi@hplindia.com

SILIGURI

1st Floor, Parasuna Bhawan, Ward No.13, Udham Singh Sarani, Asram Para, Siliguri-734001

VADODARA

409/410, Silver Oak Complex, Near Sainik Park, Char Rasta, Productivity Road, Akota, Vadodara - 390020 Gujarat
Ph.: 0265-2341747, Fax:0265-2352107
E-mail: baroda@hplindia.com

VIJAYAWADA

D.No.-29-37-135, 2nd Floor, G. R. Plaza, Eluru Road, Beside Canara Bank, Vijayawada-520002
Ph.: 0866-6622291
E-mail: vijayawada@hplindia.com

VIZAG

B.K. Towers, 49-34-1/63, 3rd Floor Akka Yyapalem Main Road, NH-5 Junction, Vizag-530016 (A.P.)
Ph.: 0891-2794506
E-mail: vizag@hplindia.com

Resident Offices:

Agartala	Balasure	Davangere	Jharsuguda	Moradabad	Silchar	Vapi
Agra	Belgaum	Durg	Jodhpur	Mysore	Surat	Varanasi
Allahabad	Berhampur	Goa	Kanyakumari	Nagercoil	Sholapur	Vellore
Anantpuram	Bhilai	Gorakhpur	Kolhapur	Nasik	Srinagar	
Aurangabad	Bhopal	Gulbarga	Kota	Patiala	Sambalpur	
Amravati	Bilaspur	Jabalpur	Madurai	Pondicherry	Tirupati	
Akola	Bijapur	Jabli	Malda	Rajkot	Trichy	
Angul	Calicut	Jamshedpur	Mangalore	Rourkela	Trivandrum	
Bareilly	Cuttack	Jalandhar	Meerut	Salem	Udaipur	



HPL Electric & Power Ltd

Corp. Office: Windsor Business Park, B-1D, Sector-10, Noida, U.P. - 201301, INDIA.
Tel.: +91-120-4656300, Fax: +91-120-4656333
Registered Office: 1/20, Asaf Ali Road, New Delhi - 110 002, INDIA.
E-mail: hpl@hplindia.com; enquiry@hplindia.com

Customer Care No. :
18004190198

www.hplindia.com

SWITCH ON YOUR ELECTRICAL PROTECTION



TAB™ : Thermal Adjustable Breaker

TAB0 : Frame Rating 10A to 125A

TAB1 : Frame Rating 20A to 160A

TAB2 : Frame Rating 63A to 250A

TAB3 : Frame Rating 250A to 500A

TAB4 : Frame Rating 500A to 800A





The TAB™ Series CONTENTS

Salient features	3
Application	4
Advantages	4
Working principle	5
Technology	6
Overview	7
Accessories	8
Product References & Ordering	9
Specifications	10
Characteristic curves	17



Salient Features The TAB™ Series

- Conforms to IS / IEC 60947- 2.
- Available in various frame sizes rated current from 10A-800A.
- Wide range of breaking capacity available from 10kA to 65kA.
- Quick-make, Quick-Break & Trip Free mechanism.
- Clear indication of 'ON', 'OFF' and 'TRIP' position.
- Low let-through energy.
- Adjustable Thermal release offers close protection from changing load.
- Line load reversibility available.
- Wide range of internal and external accessories.
- Uniform Door cut-out in line with MCB upto Size TAB 2.
- Uniform depth of MCCB upto Size TAB 2.
- RoHS Compliant.
- ISO 9001 - 2008 Certified.
- CE Marked.



MCCB is suitable for circuit protection in individual enclosures, switch board, lighting and power panels as well as motor control centers.

MCCB is assigned to protect systems against overload and short circuit up to 65KA with full range of accessories.

TAB™.....series provides the following applications :-

Distribution feeder protection	Suited for incoming and outgoing feeders
Transformer protection	Effective protection to distribution transformers as outgoing breakers.
DG set protection	Used for protection and control of diesel generating sets against overloads and short circuits.
Motor protection	MCCB provides motor back up protection, provide type -2 co-ordination (as per IEC 60947) in conjunction with suitably rated contactors and relays.
Capacitor protection	Used to protect capacitors.
Protection for semi-conductor fuses	Used to protect semiconductor fuses.
UPS protection	Used for UPS and electronic equipment protection.
DC load protection	Suitable for both AC as well as DC application for protecting rectifier panel.

Advantages

1. Compactness :

It is very compact in size and hence helps in saving space in the enclosures, panels etc. Due to its slim size it uses the distribution space very efficiently regardless of fact whether it is in residential or functional buildings.

2. Simplicity :

Its handling is easy and simple. Its simplicity and ease in use allows the user for quick installation.

3. Safe to use :

It is very safe to use. It protects people, installation and power supply distribution system. The insulation property of the material used is highly reliable and remains intact in even critical conditions.

Evolution

To reflect a variety of uses and applications, the line up has been expanded up to 65 KA with high specifications. As consumption of power is increasing, circuit breaker demands for a new level of functionality, flexibility, power and space saving has become imminent.

TAB™...series of MCCBs are with improved performance and safety.

It conforms to the latest IS & IEC standards.

The IS/IEC 60947-2 specifies the Icu (rated ultimate short circuit) and Ics (rated service short circuit) breaking capacities to the following types:-

Icu = O-CO

Ics = O-CO-CO

The rise in temperature on the terminals, body etc. after the S.C. breaking capacity test is well within limits to give better life to the product and also safeguards the entire distribution system.

Insulation

Operating Knob/Dolly is made of Thermoplastic insulating material to make it safer & reliable.

Utilization Category

Utilization category for a circuit breaker shall be stated with reference to whether or not it is specifically intended for selectivity by means of an intentional time delay (with respect to other circuit breaker in series). Utilization category is a regulation on application with respect to selectivity.

1. Utilization Category "A" :

Circuit breaker not specifically intended for selectivity under short circuit conditions. Such breakers do not have a short time withstand current rating. All Thermal-Magnetic breakers satisfy utilization category "A".

2. Utilization Category "B" :

Circuit breaker specifically intended for selectivity under short circuit conditions. Such breakers have a short time withstand current rating. All electronic-type breakers satisfy utilization category "B".

Working Principle

TAB™.....Series breakers work on current limiting principle.

Current limiting capacity of a circuit breaker is its aptitude to limit short-circuit current. When a short circuit occurs, the breaker is able to limit and lower the I²t energy release in very short time so as to protect circuits and switchgear at downstream. This is achieved by

- Intelligent design of Arc Chamber
- Guiding the arc rapidly away from the contacts in the arc chamber.
- Quick opening of main contacts.
- Quick quenching of arc by using effective arc quenching methods & materials.

Therefore I_{pk} is limited to I_c which leads to substantial reduction in electrodynamic stresses in the system. Also I²t let through proportional to the shaded area is considerably reduced, resulting in lower thermal stresses in downstream equipment and connecting cables.

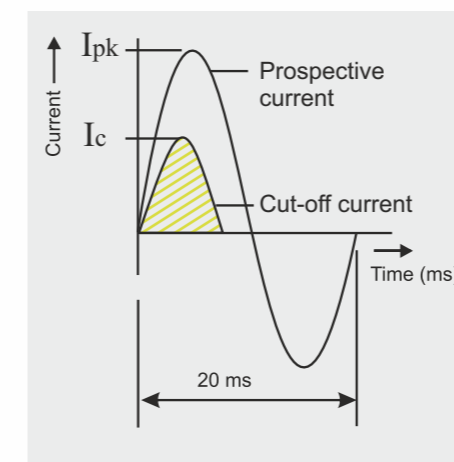



Operating Conditions

1. Temperature : MCCBs are calibrated at 40°C as reference ambient Temperature. However with increase in ambient, compensation factor to be taken into consideration.
2. Altitude : It should be less than 2000m.
3. Pollution Degree : 3

Isolation Function

These MCCBs are suitable for isolation also. As defined in IS / IEC 60947 - 2, the operation of isolation function highlights the following points:-

Contacts operation correctly indicates operating reliability of interior mechanism.

No residual current.

Higher impulse withstand voltage for terminals at the power supply side and load side.

Line-load Reversibility

MCCBs have no bias of line & load connection. The power supply can be connected from either top or bottom which has no effect on normal operation of the breaker.

The Technology For MCCB Devices

1. Arc Chamber

The MCCB arc chamber is specially designed with an arc channel as a flow guide to improve the capability of extinguishing the arc and reducing the arc distance.

2. MCCB Base And Cover

Cover and Base moulding are made of superior quality of Thermoset & Thermoplastics to with stand the stringent short circuit conditions with very high insulation strength to avoid any damage to the product. Covers are secured on Base mouldings with mounting screws tightened into threaded inserts in the MCCB base to have better strength.

3. Fixed Contact

The MCCB fixed contact does not have any mounting screws near the contact points. A steel screw can generate heat and the magnetic flux surrounding the conductor carrying the current can create a very high temperature. If a short-circuit occurs, it will cause the contact points to be welded or melted.

4. Thermal Magnetic Tripping

1. In case of Thermal overload, time-delay operation occurs when an over current heats and warps the bimetal to actuate the trip bar. (See-'A')
2. In case of Magnetic tripping, when high current passes through, the magnetization of the fix core enables it to attract the armature fixed on trip bar thereby tripping the breaker. (See-'B')

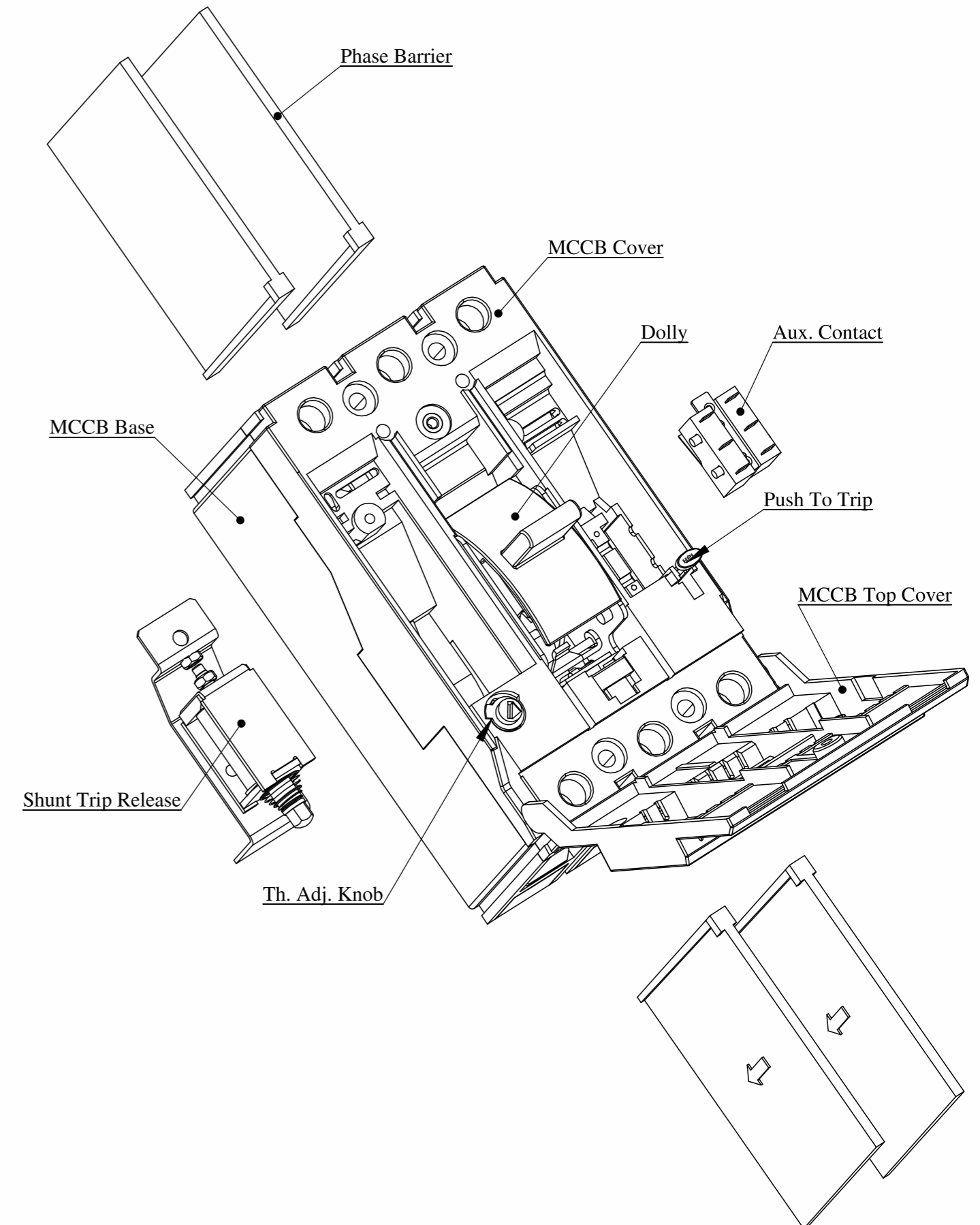
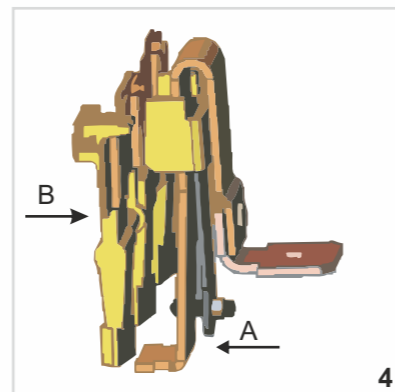
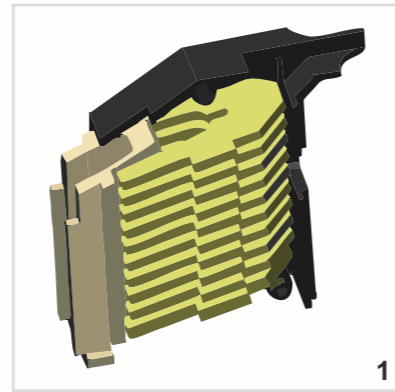



It has a wide range of accessories giving convenience and additional protection. They are of two types.

1. Internal accessory
2. External accessory.

Internal Accessories:

Shunt Trip Coil

It is a release energized by a source of voltage which may be independent of the voltage of the main circuit. It provides remote tripping of the circuit breaker. Once the MCCB trips it prevents burning of coil even if supply is continuous to coil. Its operating voltage is 70% to 110 % of rated voltage.



Undervoltage Release

It permits a mechanical switching device to open or close, with or without time delay, when voltage across release falls below a predetermined value. The normal working range is 35- 70% of the rated voltage.

Auxiliary Switch

It is used for remote signaling and control purposes. It consists of one or more than one potential free change over contact and acts as an indicator whether the circuit breaker's status is open or closed.



Alarm Switch

It is an auxiliary switch which operates only upon the tripping of the circuit breaker. It gives tripping indication once the MCCB trips.

External Accessories:

Rotary Handle

It is a toggle handle operating mechanism which serves as switching position indicator ON, OFF, TRIP. Basically it is used with breaker which is installed in an enclosure that does not allow ready access to the breaker's operating handle. The handle is allowed to be locked in the OFF or ON position for safety. This feature helps to reduce the risk associated with arc related flash burns.



Phase Barrier

Phase barriers are provided between the phases to increase the creepage distance between them thereby reducing the risk of phase to phase shorting.

Technical Features

1. Standard conformity :IS/ IEC-60947-2
2. Rated operational voltage : 415V AC
3. Rated insulation voltage: 800V AC
4. Utilization category : A
5. Rated frequency: 50/60Hz.
6. Rated impulse voltage : 8kV

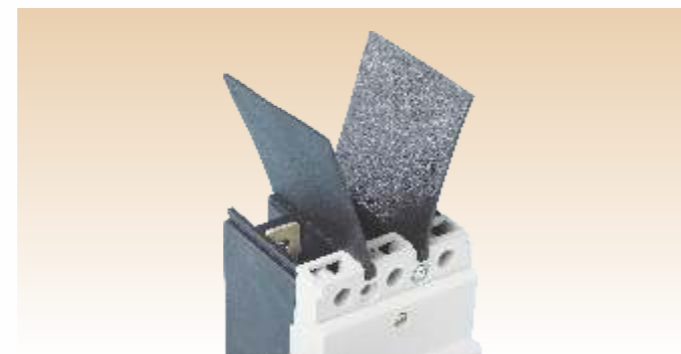

Frame Size	Breaking Capacity	Ics= % Icu	Rated Current * Tab 0	Rated Current Tab 1	Rated Current Tab 2	Rated Current Tab 3	Rated Current Tab 4	Current	No. of Main Poles
TAB 0	L : 10kA	X = 100%	10	020	063	250	500	AC	2P
TAB 1	D : 16kA	Y = 75%	16	025	080	320	630		3P
TAB 2	K : 20kA	Z = 50%	20	032	100	400	800		4P
TAB 3	C : 25kA		25	040	125	500			
TAB 4	N : 36kA		32	050	160				
	S : 50kA		40	063	200				
	H : 65kA		50	080	250				
			63	100					
			80	125					
		100	160						
		125							

TAB 1	L	X	100	AC	3P
-------	---	---	-----	----	----

- TAB 0 MCCB is available with breaking capacity 10 kA
- TAB 1 MCCB is available with breaking capacity 10 kA / 16 kA / 25 kA / 36 kA
- TAB 2 MCCB is available with breaking capacity 25 kA / 36 kA / 50 kA
- TAB 3 MCCB is available with breaking capacity 36 kA / 50 kA / 65 kA
- TAB 4 MCCB is available with breaking capacity 50 kA / 65 kA
- DC Rating against request.
- Fixed Type MCCB available from 16A to 800A, 10kA to 65kA Breaking Capacity.
- * SP MCCB in TAB 0 available from 16A to 160A, 10kA & 25kA breaking capacity

Accessories for TAB MCCB

Frame size	Shunt Release	Under Voltage Release	Auxiliary Switch	Alarm Switch	Rotary Handle
TAB 0	110 VAC	110 VAC	1 C/O	1 C/O	RHDM : Door Mounted
TAB 1	240 VAC	240 VAC	2 C/O		RHCM : Breaker Mounted
TAB 2	415 VAC	415 VAC			
TAB 3	024 VDC	024 VDC			
TAB 4	048 VDC	048 VDC			

- Product Reference for 230 VAC shunt release with TAB 1 is TAB160SHT230VAC
- Product Reference for 230 VAC under voltage release with TAB 1 is TAB160UVR230VAC
- Product Reference for 1 C/O Auxiliary switch with TAB 1 is TAB160AXC1
- Product Reference for 1 C/O Alarm Switch with TAB 1 is TAB160ALC1
- Product Reference for 1 C/O Alarm / Auxiliary Switch with TAB 1 is TAB160ALAX
- Product Reference for Rotary Handle Door Mounted with TAB 1 RHCT1ACPDM
- A Maximum 2 Nos. Internal Accessories can be selected for one Breaker, one on each side
- Shunt or Under voltage release is fitted on LHS.
- Auxiliary / Alarm Switch is fitted on RHS.

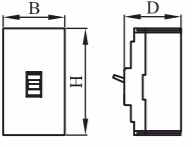

No. of poles	1	
Rated Current*	16-160A	16-160A
Rated Operational Voltage	240V ac	
Rated Insulation Voltage	690V ac	
Rated Impulse withstand voltage	8kV	
Dielectric strength	3 KV for 1 minute	
Rated Frequency	50/60 Hz	
Reference Ambient Calibration Temperature**	50°C	
Rated Ultimate S.C. Breaking Capacity (at 240 Vac, 50/60 Hz) Icu in kA	25	10
Rated Ultimate S.C. Breaking Capacity (at 250 Vdc) Icu in kA	5	5
Rated Service S.C. Breaking Capacity (at 240 Vac, 50/60 Hz) Ics in kA	75% Icu=18.75 kA	100% Icu=10 kA
Rated S.C. Making Capacity (at 240 VAC, 50/60 Hz) Icm in kA	52.5	17
Utilization Category	A	
Positive Isolation	Available	
No. of operating cycles	Mechanical-20000; Electrical-5000	
Type of Releases	Thermal - Magnetic	
Thermal Release Setting	Fixed	
Magnetic Release Setting	Fixed	
Terminal Capacity (Cables)	50mm ² max.	
Terminal Capacity (Link)	70mm ² max.	
Terminal Capacity (Busbar width for direct mounting)	16 mm max.	
Size (H x B x D)	 <p>Dimension H=130mm B=25mm D=70mm</p>	
Weight (Tolerance ±10%)	0.36Kg	
Reference Standards	IS / IEC 60947-2	

- Notes :-
- *Continuous current rating available are 16, 20, 25, 32, 40, 50, 63, 80, 90, 100, 120, 135 & 160 Amps.
 - **However on demand, MCCBs can be provided with calibration done at higher temperature also.
 - Extended terminals available as standard from 100A onwards
 - Weight shown above is for the highest rating of MCCB in the Frame size

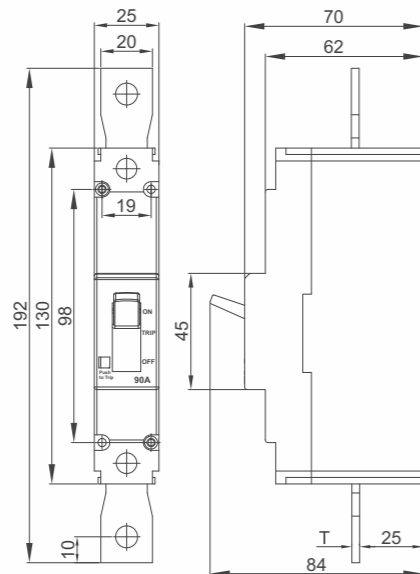

Extended Terminal details

Rating	Thickness (T)
100A	2mm
125A	2.5mm
160A	3mm

Note: All dimensions are in mm with ± 5% Tolerance.

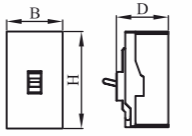

No. of poles	1		
Type	C	N	S
Rated Current*	63, 80 100, 125, 160, 200 & 250A		
Rated Operational Voltage	240V		
Rated Insulation Voltage	800V		
Rated Impulse withstand voltage	8kV		
Dielectric strength	3 KV for 1 minute		
Rated Frequency	50/60 Hz		
Reference Ambient Calibration Temperature**	50°C		
Rated Ultimate S.C. Breaking Capacity (at 240 VAC, 50/60 Hz) Icu in kA	25	36	50
Rated Ultimate S.C. Breaking Capacity (at 250 VDC) Icu in kA	10	10	10
Rated Service S.C. Breaking Capacity (at 240 VAC, 50/60 Hz) Ics in kA	100% Icu	100% Icu	50% Icu
Rated S.C. Making Capacity (at 240 VDC, 50/60 Hz) Icm in kA	52.5	75.6	105
Utilization Category	A		
Positive Isolation	Available		
No. of operating cycles	Mechanical-20000; Electrical-5000		
Type of Releases	Thermal-Magnetic		
Thermal Release Setting	Adjustable 80-100%		
Magnetic Release Setting	Fixed		
Terminal Capacity (Cable)	95mm ² max.		
Terminal Capacity (Link)	120mm ² max.		
Terminal Capacity (Busbar width for direct mounting)	22 mm max.		
Size (H x B x D)	 <p>Dimension H=150mm B=47mm D=82mm</p>		
Weight (Tolerance ±10%)	0.90kg		
Reference Standards	IS/IEC 60947-2		

- Notes :-
- *Continuous current rating available are 63, 80, 100, 125, 160, 200 & 250Amps.
 - **However on demand, MCCBs can be provided with calibration done at higher temperature also.
 - Extended terminals available as standard from 100A onwards
 - Weight shown above is for the highest rating of MCCB in the Frame size

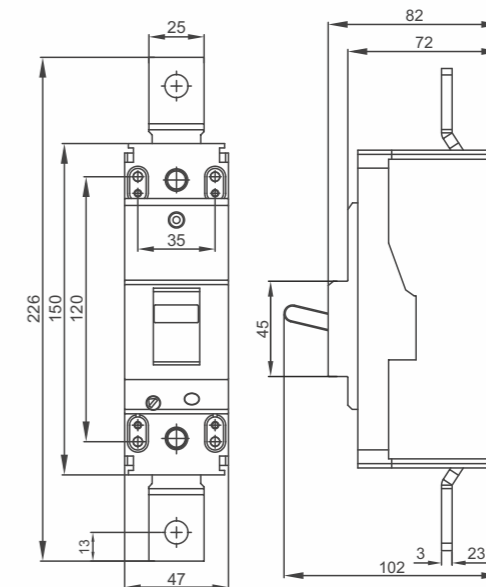

Note: All dimensions are in mm with ± 5% Tolerance.



No. of poles	3/4		
Type	G	L	K
Rated Current*	10, 16, 20, 25, 32, 40, 50, 63, 80, 100, 125A		
Rated Operational Voltage	415V ac		
Rated Insulation Voltage	690V ac		
Rated Impulse withstand voltage	6 kV		
Dielectric strength	3 KV for 1 minute		
Rated Frequency	50/60 Hz		
Reference Ambient Calibration Temperature**	40°C		
Rated Ultimate S.C. Breaking Capacity (at 415 Vac, 50/60 Hz) Icu in kA	10kA	10kA	20kA
Rated Ultimate S.C. Breaking Capacity (at 250 Vdc) Icu in kA	5 kA		
Rated Service S.C. Breaking Capacity (at 415 Vac, 50/60 Hz) Ics in kA	50% Icu=5kA	100% Icu=10kA	50% Icu=10kA
Rated S.C. Making Capacity (at 415 VAC, 50/60 Hz) Icm in kA	17	17	40
Utilization Category	A		
Positive Isolation	Available		
No. of operating cycles	Mechanical-20000; Electrical-5000		
Type of Releases	Thermal - Magnetic		
Release Setting Thermal	Fixed		
Release Setting Magnetic	Fixed		
Terminal Capacity (Cables)	50mm ² max.		
Terminal Capacity (Link)	50mm ² max.		
Terminal Capacity (Busbar width for direct mounting)	16 mm max.		
Size (H x B x D)mm		Dim. H B D	3P 130 75 68.5 4P 130 100 68.5
Weight (Tolerance ±10%)	0.93Kg(3P) & 1.2Kg(4P)		
Reference Standards	IS / IEC 60947-2		

- Notes :-
- *Continuous current rating available are 10, 16, 20, 25, 32, 40, 50, 63, 80, 100 & 125 Amps.
 - **However on demand, MCCBs can be provided with calibration done at higher temperature also.
 - Extended terminals available as standard from 100A onwards
 - Weight shown above is for the highest rating of MCCB in the Frame size.

Rating	Thickness (T)
100A	2mm
125A	3mm

Note: All dimensions are in mm with ± 5% Tolerance.

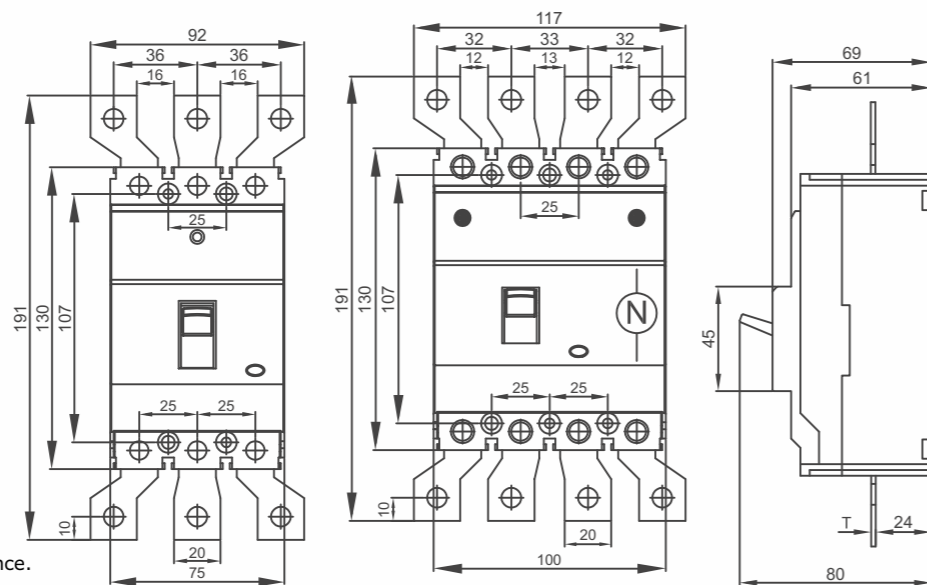

Thermal Adjustable Breaker



No. of poles	3/4			
Type	L	D	C	N
Rated Current*	20-160A	20-160A	20-160A	20-160A
Rated Operational Voltage	415V			
Rated Insulation Voltage	800V			
Rated Impulse withstand voltage	8kV			
Dielectric strength	3 KV for 1 minute			
Rated Frequency	50/60 Hz			
Reference Ambient Calibration Temperature**	40°C			
Rated Ultimate S.C. Breaking Capacity (at 415 VAC, 50/60 Hz) Icu in kA	10	16	25	36
Rated Ultimate S.C. Breaking Capacity (at 230 VAC, 50/60 Hz) Icu in kA	16	25	40	50
Rated Ultimate S.C. Breaking Capacity (at 250 VDC) Icu in kA	12	12	12	12
Rated Service S.C. Breaking Capacity (at 415 VAC, 50/60 Hz) Ics in kA	100% Icu	100% Icu	75% Icu	50% Icu
Rated Service S.C. Breaking Capacity (at 230 VAC, 50/60 Hz) Ics in kA	100% Icu	100% Icu	75% Icu	50% Icu
Rated S.C. Making Capacity (at 415 VAC, 50/60 Hz) Icm in kA	17	32	52.5	75.6
Utilization Category	A			
Positive Isolation	Available			
No. of operating cycles	Mechanical-25000; Electrical-7000			
Type of Releases	Thermal - Magnetic			
Release Setting Thermal***	80-100% Adjustable			
Release Setting Magnetic	Fixed			
Terminal Capacity (Cables)	50mm ² max.			
Terminal Capacity (Link)	70mm ² max.			
Terminal Capacity (Busbar width for direct mounting)	16 mm max.			
Size (H x B x D)		Dim. H B D	3P 130 75 79 4P 130 100 79	
Weight (Tolerance ±10%)	1.1Kg (3P) & 1.5Kg (4P) (For Highest Rating)			
Reference Standards	IS / IEC 60947-2			

- Notes :-
- *Continuous current rating available are 20, 25, 32, 40, 50, 63, 80, 100, 125 & 160 Amps.
 - **However on demand, MCCBs can be provided with calibration done at higher temperature also.
 - ***MCCB also available with fixed thermal release setting.
 - Extended terminals available as standard from 100A onwards.

Rating	Thickness (T)
100A	2mm
125-160A	3mm

Note: All dimensions are in mm with ± 5% Tolerance.

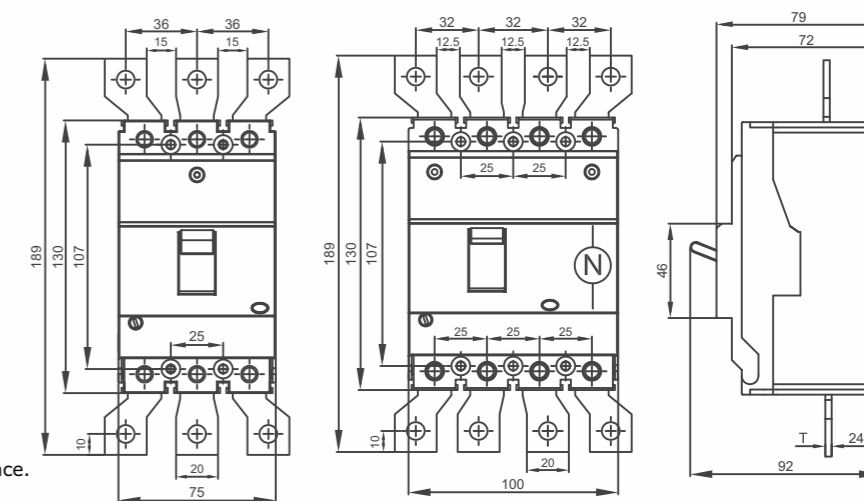

Thermal Adjustable Breaker

Specifications The TAB™ 2 MCCB Series



No. of poles	3/4		
Type	C	N	S
Rated Current*	63-250A	63-250A	63-250A
Rated Operational Voltage	415V		
Rated Insulation Voltage	800V		
Rated Impulse withstand voltage	8kV		
Dielectric strength	3 KV for 1 minute		
Rated Frequency	50/60 Hz		
Reference Ambient Calibration Temperature**	40°C		
Rated Ultimate S.C. Breaking Capacity (at 415 VAC, 50/60 Hz) Icu in kA	25	36	50
Rated Ultimate S.C. Breaking Capacity (at 230 VAC, 50/60 Hz) Icu in kA	40	50	70
Rated Ultimate S.C. Breaking Capacity (at 250 VDC) Icu in kA	20	20	20
Rated Service S.C. Breaking Capacity (at 415 VAC, 50/60 Hz) Ics in kA	100% Icu	100% Icu	50% Icu
Rated Service S.C. Breaking Capacity (at 230 VAC, 50/60 Hz) Ics in kA	100% Icu	100% Icu	50% Icu
Rated S.C. Making Capacity (at 415 VAC, 50/60 Hz) Icm in kA	52.5	75.6	105
Utilization Category	A		
Positive Isolation	Available		
No. of operating cycles	Mechanical-20000; Electrical-5000		
Type of Releases	Thermal-Magnetic		
Thermal Release Setting***	Adjustable 80-100%		
Magnetic Release Setting	Fixed		
Terminal Capacity (Cable)	95mm ² max.		
Terminal Capacity (Link)	120mm ² max.		
Terminal Capacity (Busbar width for direct mounting)	22 mm max.		
Size (H x B x D)mm	Dim.	3P	4P
	H	150	150
	B	105	140
	D	82	82
Weight (Tolerance ±10%)	2.2Kg (3P) & 2.8Kg (4P)		
Reference Standards	IS/IEC 60947-2		

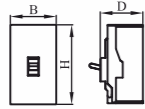

- Notes :-
- *Continuous current rating available are 63, 80, 100, 125, 160, 200 & 250 Amps.
 - **However on demand, MCCBs can be provided with calibration done at higher temperature also.
 - ***MCCB also available with fixed thermal release setting.
 - Weight shown above is for the highest rating of MCCB in the Frame size

Extended Terminal details

Rating	Thickness (T)
100-160A	4mm
200-250A	5mm

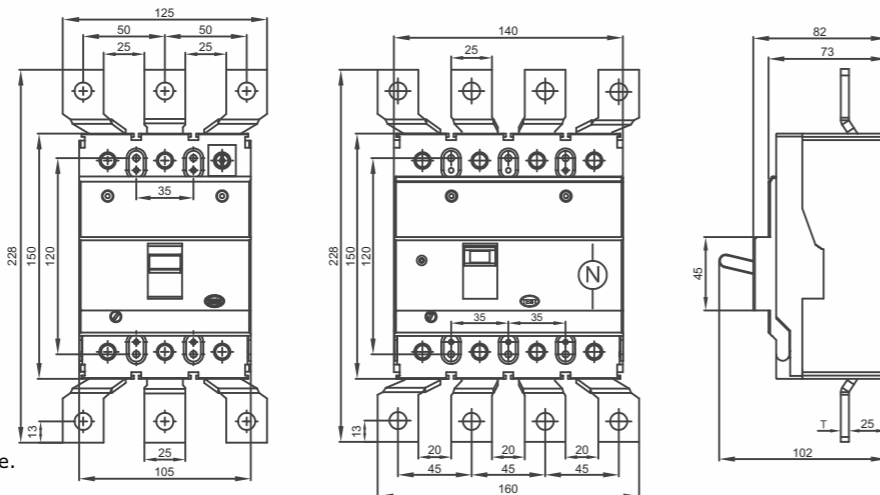

Note: All dimensions are in mm with ± 5% Tolerance.

Thermal Adjustable Breaker

Specifications The TAB™ 3 MCCB Series



No. of poles	3/4		
Type	N	S	H
Rated Current*	250-500A	250-500A	250-500A
Rated Operational Voltage	415V		
Rated Insulation Voltage	800V		
Rated Impulse withstand voltage	8kV		
Dielectric strength	3 KV for 1 minute		
Rated Frequency	50/60 Hz		
Reference Ambient Calibration Temperature**	40°C		
Rated Ultimate S.C. Breaking Capacity (at 415 VAC, 50/60 Hz) Icu in kA	36	50	65
Rated Ultimate S.C. Breaking Capacity (at 230 VAC, 50/60 Hz) Icu in kA	65	85	95
Rated Ultimate S.C. Breaking Capacity (at 250 VDC) Icu in kA	20	25	35
Rated Service S.C. Breaking Capacity (at 415 VAC, 50/60 Hz) Ics in kA	100% Icu	75% Icu	50% Icu
Rated Service S.C. Breaking Capacity (at 230 VAC, 50/60 Hz) Ics in kA	100% Icu	75% Icu	50% Icu
Rated S.C. Making Capacity (at 415 VAC, 50/60 Hz) Icm in kA	76	105	143
Utilization Category	A		
Positive Isolation	Available		
No. of operating cycles	Mechanical-15000; Electrical-3000		
Type of Releases	Thermal-Magnetic		
Thermal Release Setting***	Adjustable 70-100%		
Magnetic Release Setting***	Adjustable 6In - 10In		
Terminal Capacity (Cable)	-		
Terminal Capacity (Link)	320mm ² max.		
Terminal Capacity (Busbar width for direct mounting)	28 mm max.		
Size (H x B x D)mm	Dim.	3P	4P
	H	258	258
	B	140	184
	D	116	116
Weight (Tolerance ±10%)	7.1Kg (3P) & 9.2Kg (4P)		
Reference Standards	IS/IEC 60947-2		

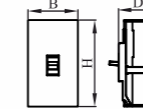

- Notes :-
- *Continuous current rating available are 250, 315, 400, 500 & 630A.
 - **However on demand, MCCBs can be provided with calibration done at higher temperature also.
 - ***MCCB also available with fixed thermal & magnetic release setting.
 - Weight shown above is for the highest rating of MCCB in the Frame size

	3-Pole		4-Pole	
	Dom.	Export	Dom.	Export
a	342	403	342	403
b	140	188	184	232
c	56	74	56	64
d	28	34	28	24
e	28	40	28	40
f	16	20	16	20
g	33	40	33	40

Extended Terminal details

Rating	Thickness (T) for Domestic	Thickness (T) for Export
250A	4mm (Local Queue Type)	4mm
315A-400A	6mm (Local Queue Type)	6mm
500A	6mm	6mm

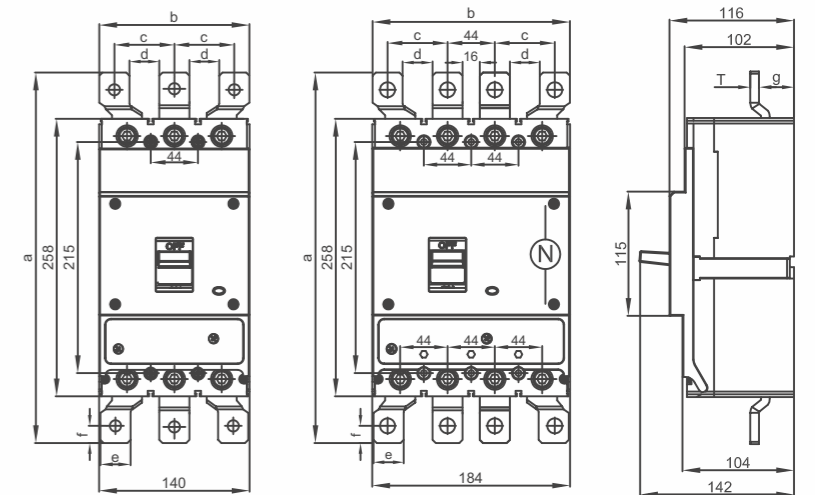

Note: All dimensions are in mm with ± 5% Tolerance.

Thermal Adjustable Breaker



No. of poles	3/4		
Type	N	S	H
Rated Current*	500, 630, 800A		
Rated Operational Voltage	415V		
Rated Insulation Voltage	800V		
Rated Impulse withstand voltage	8kV		
Dielectric strength	3 KV for 1 minute		
Rated Frequency	50/60 Hz		
Reference Ambient Calibration Temperature**	40°C		
Rated Ultimate S.C. Breaking Capacity (at 415 VAC, 50/60 Hz) Icu in kA	36	50	65
Rated Ultimate S.C. Breaking Capacity (at 230 VAC, 50/60 Hz) Icu in kA	65	85	95
Rated Ultimate S.C. Breaking Capacity (at 250 VDC) Icu in kA	20	25	35
Rated Service S.C. Breaking Capacity (at 415 VAC, 50/60 Hz) Ics in kA	100% Icu	75% Icu	50% Icu
Rated Service S.C. Breaking Capacity (at 230 VAC, 50/60 Hz) Ics in kA	100% Icu	75% Icu	50% Icu
Rated S.C. Making Capacity (at 415 VAC, 50/60 Hz) Icm in kA	76	105	143
Utilization Category	A		
Positive Isolation	Available		
No. of operating cycles	Mechanical-5000; Electrical-2500		
Type of Releases	Thermal-Magnetic		
Thermal Release Setting***	Adjustable 70-100%		
Magnetic Release Setting***	Adjustable 6In - 10In		
Terminal Capacity (Cable)	-		
Terminal Capacity (Link)	500mm ² max.		
Terminal Capacity (Busbar width for direct mounting)	42 mm max.		
	Dimensions		
Size (H x B x D)	Dim.	3P	4P
	H	280	280
	B	210	280
	D	120	120
Weight (Tolerance ±10%)	12.4Kg (3P) & 16.2Kg (4P)		
Reference Standards	IS/IEC 60947-2		

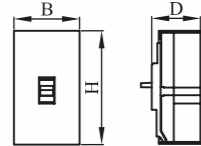

- Notes :-
- *Continuous current rating available 500, 630 & 800Amps.
 - **However on demand, MCCBs can be provided with calibration done at higher temperature also.
 - ***MCCB also available with fixed thermal & magnetic release setting.
 - Weight shown above is for the highest rating of MCCB in the Frame size

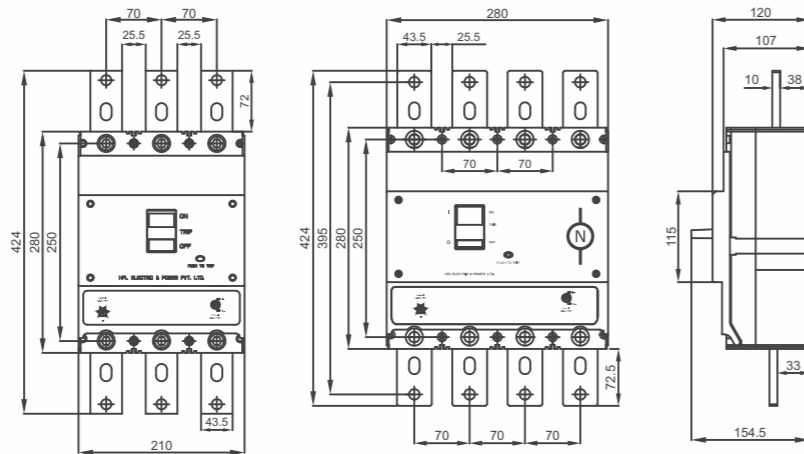

Note: All dimensions are in mm with ± 5% Tolerance.



Time Current Characteristic Curve (TAB-1)

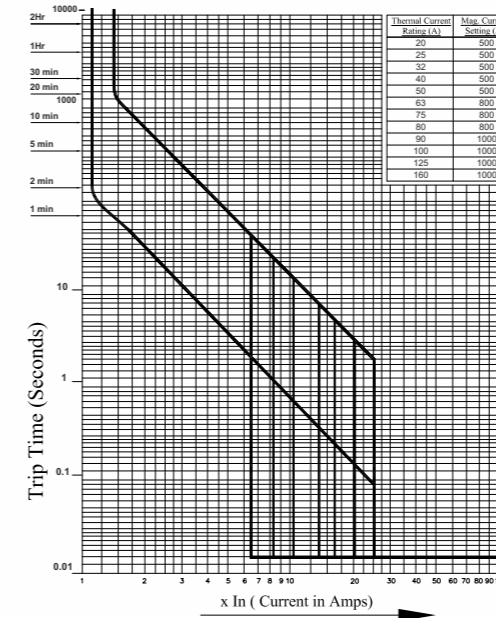

Ambient Compensation Curve (TAB-1)

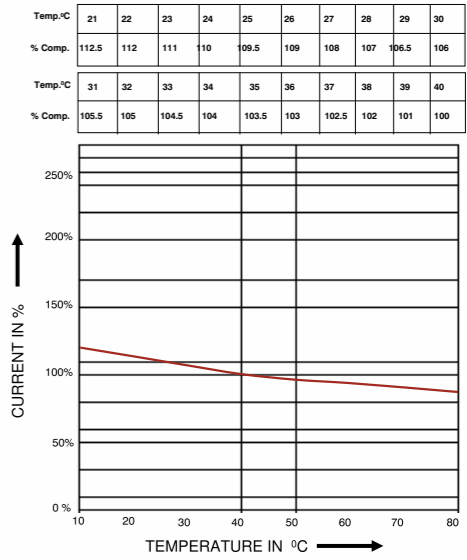

Time Current Characteristic Curve (TAB-2)

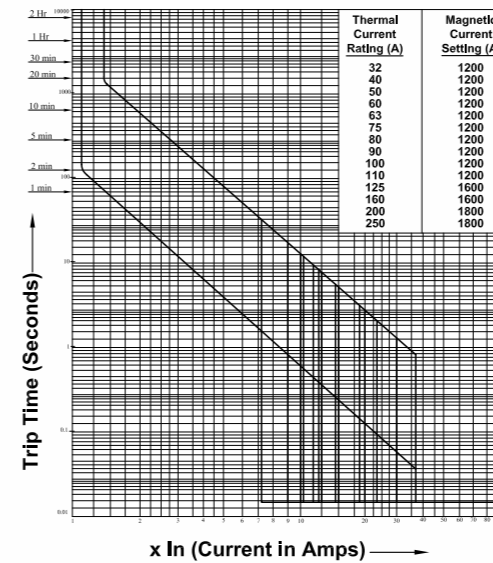

Ambient Compensation Curve (TAB-2)

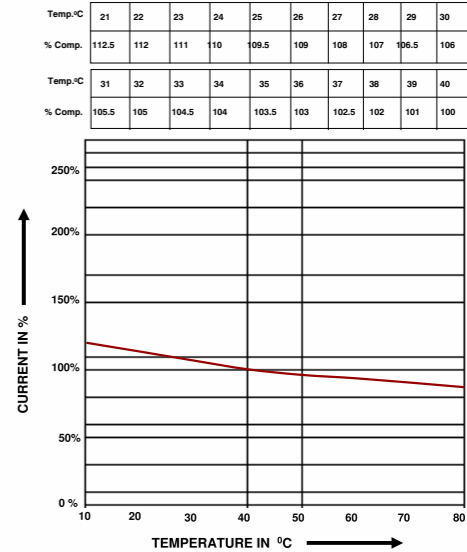

Time Current Characteristic Curve (TAB-3/4)

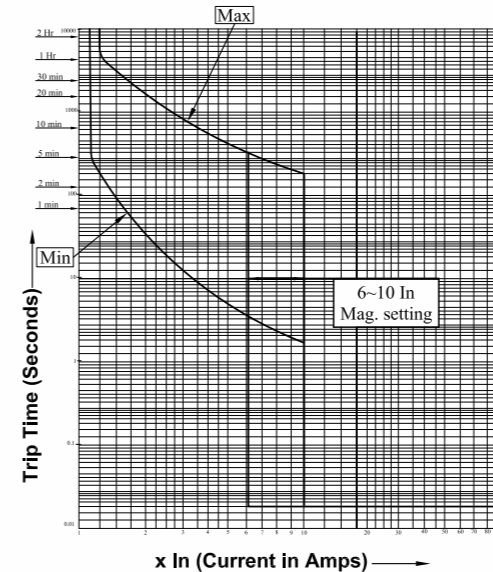

Ambient Compensation Curve (TAB-3/4)

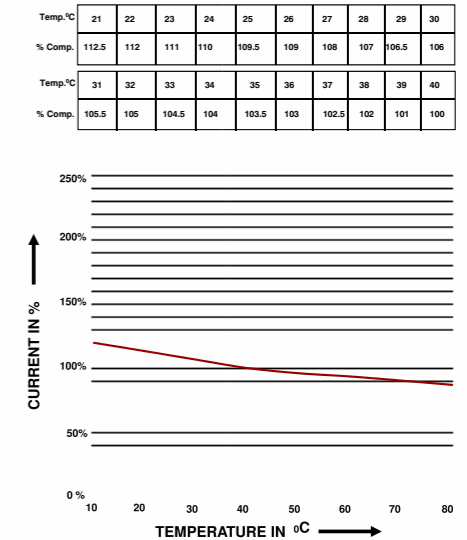



Other HPL Industrial Products



ACB



Controlgear



On Load Changeover Switch

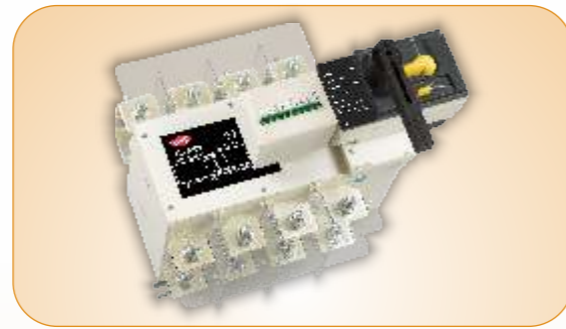

Automatic Transfer Switch



Switch Disconnecter Fuse

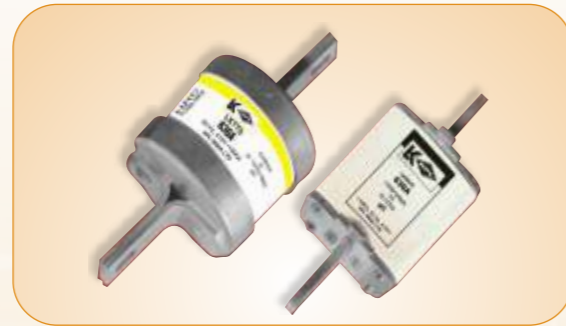

HRC Fuse Link



MCB / RCCB



Energy Meters

Notes